

SPOSgroup

A leading provider of retail marketing solutions

"We design, make, procure, sell, manage and supply the products that sell your products"

SPOSgroup

Healey
Creative

spos

posm
solutions

Disclaimer:

The information in this catalogue is the intellectual property of SPOS Group and is confidential, and intended solely for the Addressee. If you have received this information in error, please delete it immediately and notify the sender. Any copying or further distribution beyond the original addressee is not permitted, and may be unlawful. In receiving this information you agree that any intellectual property rights in the POP Goods, Services or Concepts contained within are and shall remain the property of SPOS.

THE ORIGINAL

Retail Solutions Company

Since first introduced datastrip to the Australian market over 30 years ago, SPOS has grown to become the market leader in retail marketing solutions.

We operate primarily in Asia, Australia & NZ but have delivered several global projects. SPOS Group is wholly owned by HGL, which is Australia's oldest publicly listed company on the Australian stock exchange.

WHAT WE DO...

SPOS Group work with brand owners and retailers to maximise shopper engagement through delivering the optimal retail experience.

OUR ENABLERS

Our large knowledge and experience base from extensive exposure to multiple brands, categories, retail environments and markets. Our vertical structure across design, development, supply and distribution operations.

OUR RESULTS

SPOS are endorsed many times over through local/global awards and recognition programs but, most importantly, by our large, loyal and valued client base across ANZ and the world.

- 
'BELOW THE LINE' SERVICES
 Retail Activation Management & Partnership with clients across Retail Operations, Innovation, Marketing & Sales Teams
- 
INDUSTRIAL DESIGN
 Conceptualisation, engineering & Strategy Solutions
- 
PROJECT MANAGEMENT
 From Concept to Delivery & everything in between
- 
GRAPHIC DESIGN
 Visualisation & Post-production
- 
STRATEGIC PROCUREMENT & SUPPLY
 For ongoing or one-off Brand & Retail POP Supply & Distribution
- 
PRODUCTION
 Prototype & Manufacture
- 
DELIVER
 Logistics & Distribution
- 
ACTIVATION
 Installation & Review

HOW WE WORK

We play in the space where the shopper becomes a purchaser.

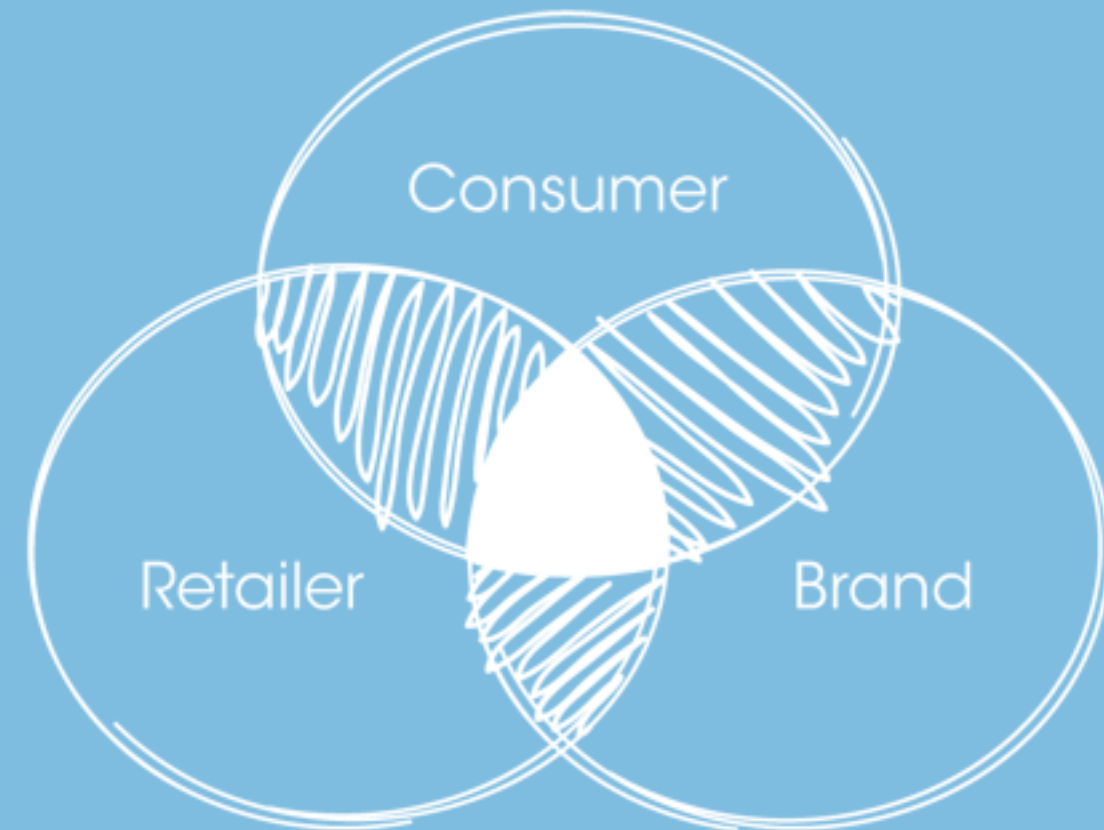

 = Insight Engagement & Experiences

 = Where the Shopper Becomes a Purchaser!

WHAT ARE THE RESULTS

Our products help sell your products.

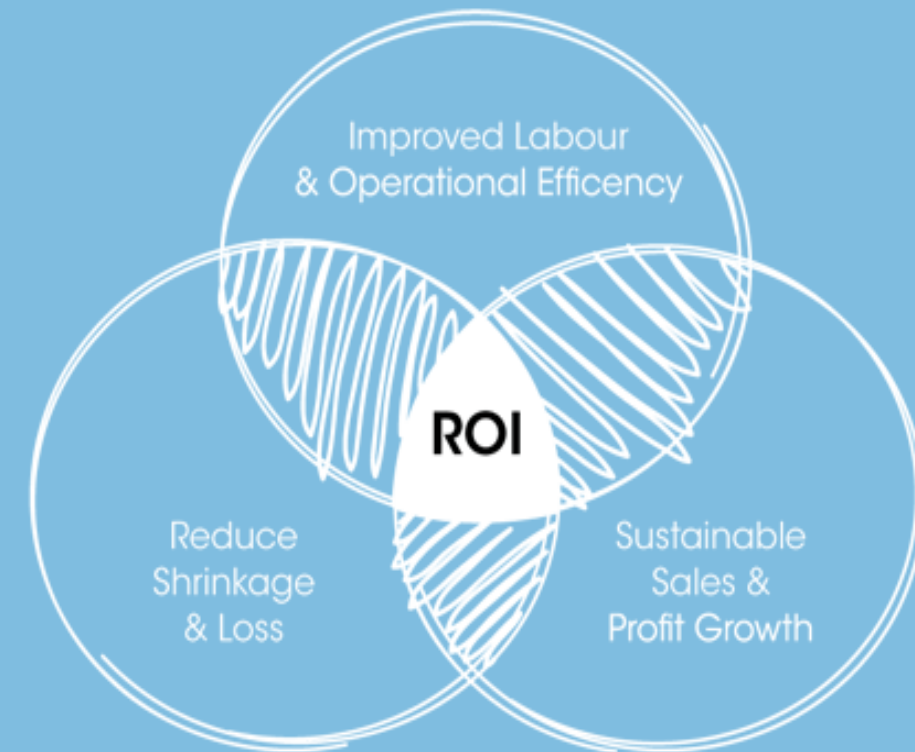

 = SPOS Group Products

 = Return On Your Investment

The multiplier effect of these delivers superior commercial outcomes for our client partners.

CLIENTS

Some of our valued clients...

"We enable our clients to become successful thriving brands and retailers"...

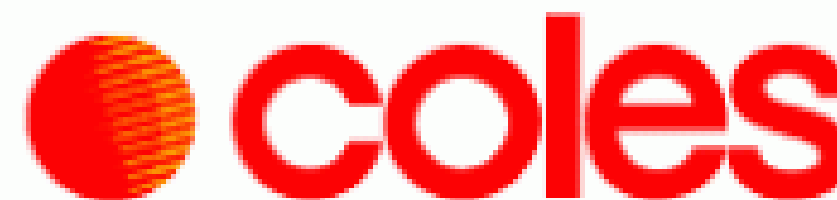
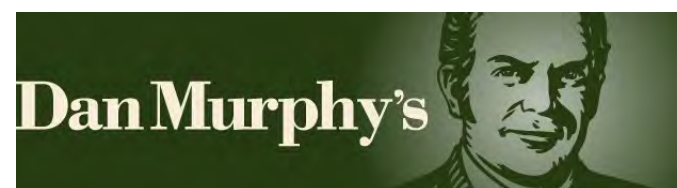

SPOS New Website Launch

We are excited to invite our valued clients to explore our brand new SPOS website!

The new website aims to provide our clients with a comprehensive resource to find the right solution for your retail merchandising needs. We showcase our best products, and design capabilities as well as access to our Webstores for online purchases. In the not distant future, we will be releasing our new SPOS Webstore, which will provide an unparalleled offer of products combining both the SPOS and POSM offering into one, easy to use, web store.

Visit the Site
www.sposgroup.com



Global First Merchandising Innovation from SPOS!

Delivering Sales Growth through Innovative Product Merchandising is a key factor of success with consumer goods, brands and retailers so we are very excited to be introducing ProGlide into both the Australian and New Zealand markets.

ProGlide's gentle fronting motion is proven to deliver strong sales growth. This combined with a reduction in stock replenishment and manual product fronting "facing up" time makes it a high ROI asset to any brand or retailer.

*Unique Patented Technology
Controlled Gentle Feed
Modular Design
Easy Installation*

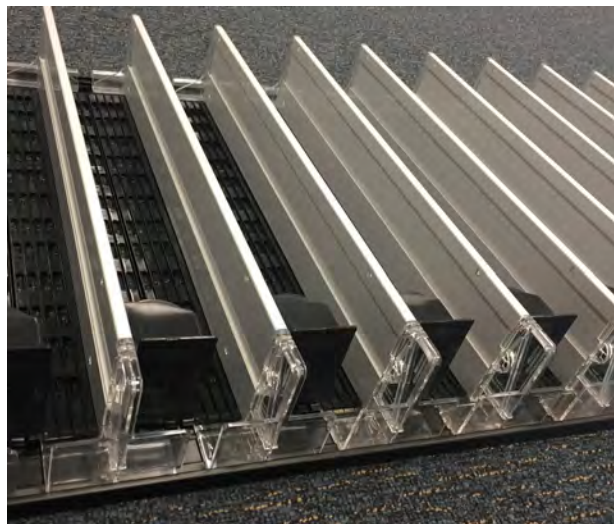

Extensive trials delivering amazing results are already underway with our partners across a wide variety of categories, Liquor, Health and Beauty, Manchester and Automotive to name a few and SPOS have recently commenced our own trials in the Liquor and Confectionery categories in both Australia and New Zealand and this will extend into new product categories in the coming months.

POSM Solutions is now a part of SPOS Group!

The logo for SPOSgroup, featuring the text "SPOSgroup" in white on a dark purple rectangular background.

POSM like SPOS is an Australian business and a leading provider for marketing and retail solutions in Australia and New Zealand.

Both have provided expert retail & point of sale solutions for Australia and New Zealand for over 30 years. The recent acquisition of POSM Solutions gives SPOS Group an even wider range of products designed to help you drive sales higher. We pride ourselves on providing quality products, fast delivery and leading customer service at competitive prices. Our merchandising solutions provide a wide range of quality shop fittings, signage, display solutions & accessories. If you can't find the right product on our POSM Webstore, iCandyCreative specialise in bespoke retail solutions for a truly unique and effective approach to driving your product.

SPOS Strategic Procurement and Supply

SPOSgroup

SPOS Strategic Procurement & Supply

SPOS Group possesses a large knowledge base & experienced supply chain that allows us to deliver on large scale & ongoing supply and distribution.



We have had experience in roll-outs of stores exceeding 500 in number, all delivered impeccable and on time. These stores can't open without our product, and we have delivered repeated positive results, on time, every time.



SPOS holds the necessary supply infrastructure to guarantee the reliability and success of any size project in Australia.



Shelf Communication Made Easy

Australia's largest provider of Datastrips & Accessories

Flat Datastrip

Our most popular style of datastrip with adhesive backing tape. Commonly used in supermarkets and other retail outlets around the world to display ticketing at the shelf edge.

Standard heights(mm): 26 - 76
Various colours available
Standard lengths 915mm-1200mm

Available with standard tape (TP), foam tape (TF) and double tape (TTP) if requested. Some styles are available up to 1240mm. Other lengths available on request. Minimum order quantities may apply.



Angled Datastrip

Angled datastrip provides greater readability in some situations. At an angle ticket information is easier to view, especially on lower shelves where shoppers may need to bend to read tickets displayed in flat datastrip.

Standard heights(mm): 26 - 39
Various angles and colours available
Standard lengths 915mm-1200mm

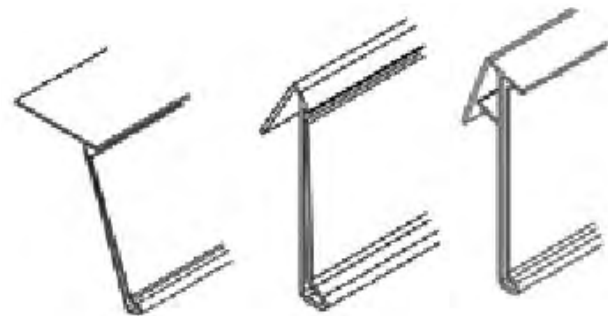

Branding Strips

Curved branding strip sits on top of the shelf edge and has a divider attachment rail integrated into the rear of the strip. Branding strip provides a smart looking way to present branding and product information as well as an easy way to maintain on shelf category segmentation using colour or information blocking.



Hanging Datastrip

Angled datastrip provides greater readability in some situations. At an angle ticket information is easier to view, especially on lower shelves where shoppers may need to bend to read tickets displayed in flat datastrip.



Thin Datastrip

Some applications require a smaller profile, DBL is a flat datastrip with adhesive tape backing that fits 17mm and 23mm high tickets.



Clip-On Datastrip

Clip-on/over style datastrips are another great solution for wire baskets, glass shelves and wire shelf fronts in refrigerated areas. For greatest versatility these profiles are two part solutions made up of a clear rear piece which is attached to your preferred type of flat datastrip.

Various sizes/profiles available.



Double Datastrip

Use our CGS or GSN profiles to construct double or multiple datastrip profiles where extra information or ticketing is required. Useful for product education and category navigation.



Shelf Merchandising Made Easy

ORGANISED - EFFECTIVE - PROFITABLE

SPOS shelf management systems are the complete answer to Optimal Shelf Merchandising



Standard Datastrips

We stock a wide range of Datastrips for all shelf types in various colours and sizes.



Brand Display Kits

Provide an integrated front riser and label pocket.

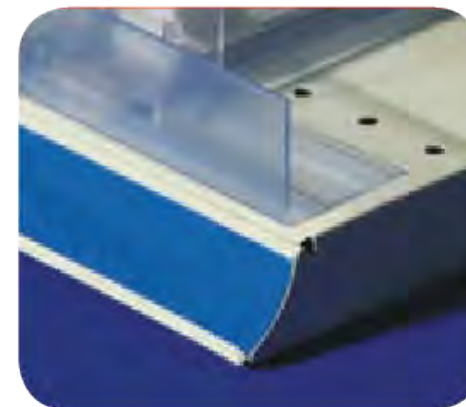

Front Risers

Provide an integrated front riser and label pocket.

FlexRoller

Designed to Deliver



FlexRoller

Flexible and scalable automatic front-facing merchandising system to reduce merchandising costs and deliver sales lift through enhanced product presentation on-shelf.



Specialty Datastrips

Access to 100's of specialty oversize datastrip profiles.



Product Dividers

Access to 100's of specialty oversize datastrip profiles.



Promo Accessories

Widgets, clips and accessories to promote your products.

A wide range of products for any application...

ORGANISED - EFFECTIVE - PROFITABLE



Breakable Shelf Pushers

A breakable pusher sledge to suit any length. Breaking points are every 25mm. Various backing profiles, sizes and spring strengths available to suit or various weight products.



Shelf Dividers

Various heights and sized breakable dividers. Each base length has breaking points every 25mm. Various front and clip profiles available to suit many applications. L and T fronts also available.



Risers and Rails

Risers and rails sit on top of the shelf edge and allow divider attachments to be mounted securely at the front and rear. Risers with integrated branding strips provide additional category segmentation using colour or information blocking.



L&T Dividers

Negate the need for a front riser rail, and increase product facing exposure with specialty dividers combined SPOS shelf pushers and rail kits.

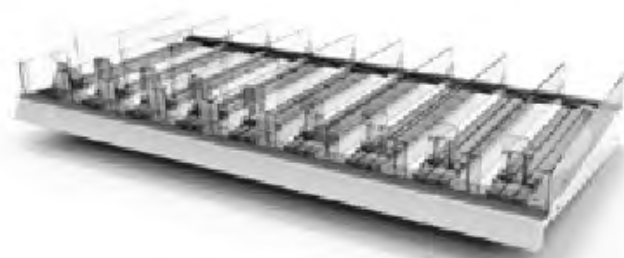

Full Shelf Pusher Kits

SPOS can arrange pre-assembled shelf merchandising and pusher kits direct to shelf or applied to a layover mat enabling rapid installation, saving merchandising set-up time at the shelf.



Specialty & Freezer Pushers

SPOS offer a wide range of specialised pushers for various retail environments including adjustable Salad pushers, and heavy-duty freezer pushers, made from materials engineered to function optimally at sub-zero temperatures.

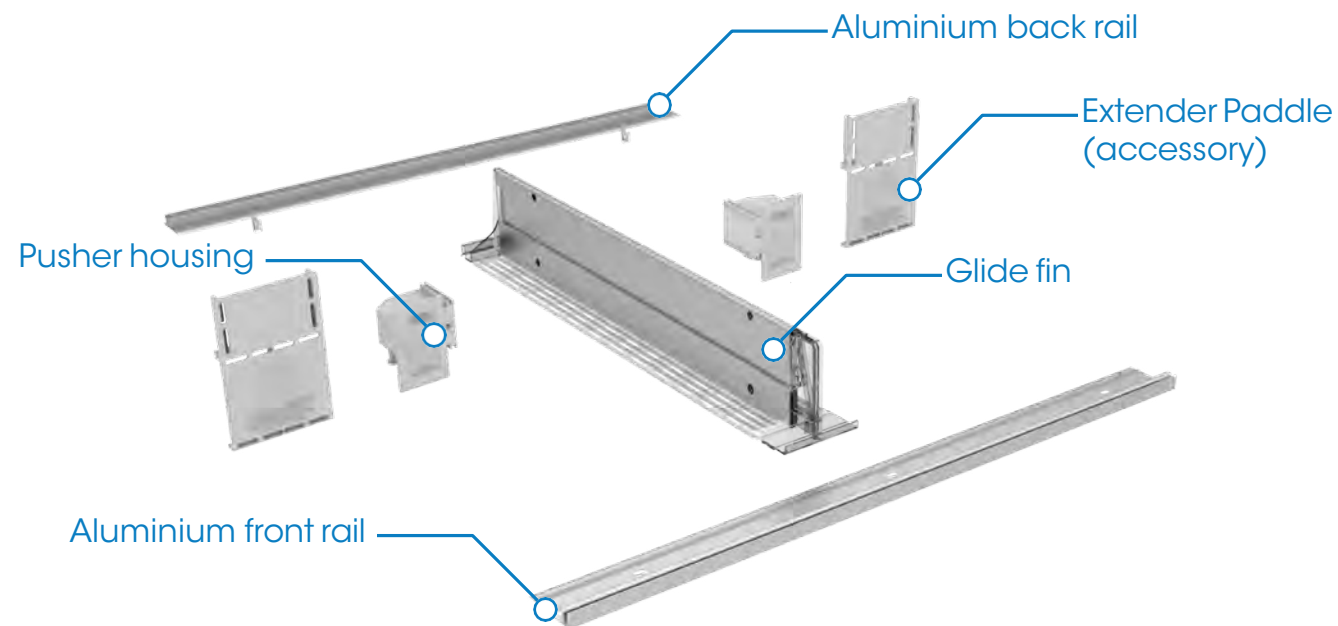

Introducing the ProGlide, a gentle fronting merchandiser.

- Gentle fronting motion that drives sales
- Controlled feed for multiple categories
- Fast and simple replenishment that saves labor
- Modular flexible planogram for complete flexibility on width
- Depth versatility from 270 to 770mm
- Easy installation with no tools required

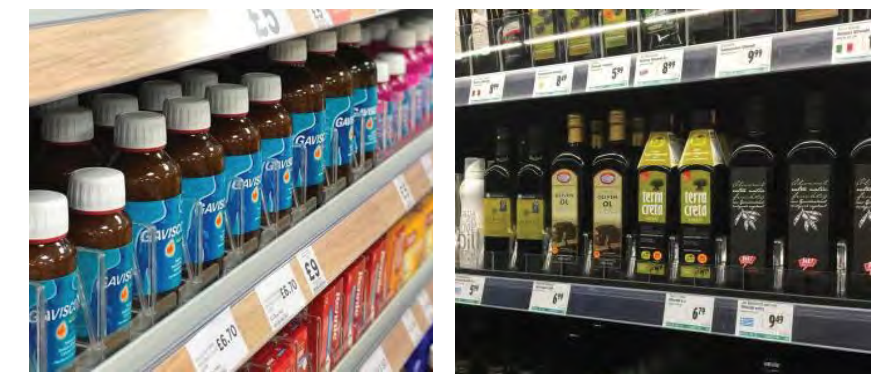
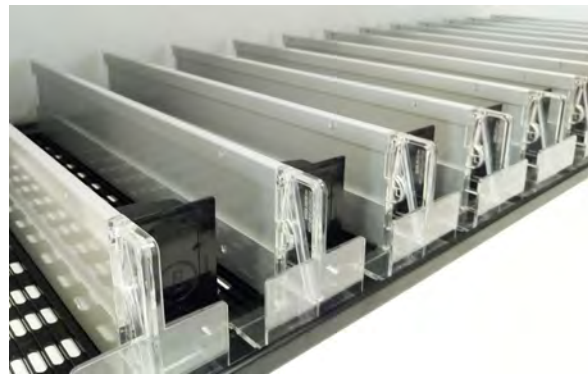

Introducing the VersaPusher, a versatile fronting merchandiser.

- Components install onto back back - no shelf required
- Aluminium tracks deliver efficient fronting
- Durable construction
- Dividers easily adjust to suit 120mm - 200mm wide packages
- Expandable pusher housing
- Easy installation

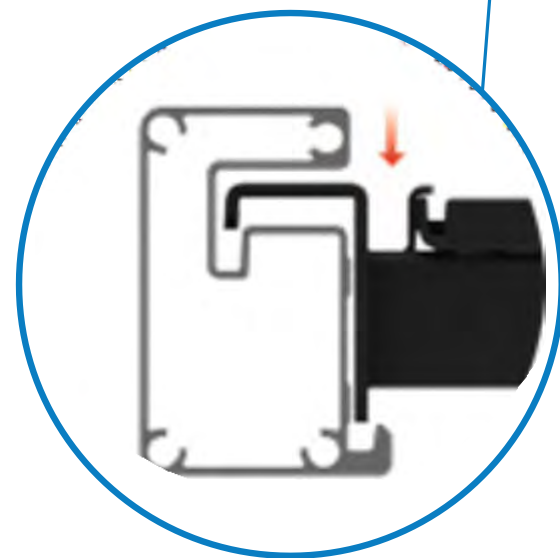
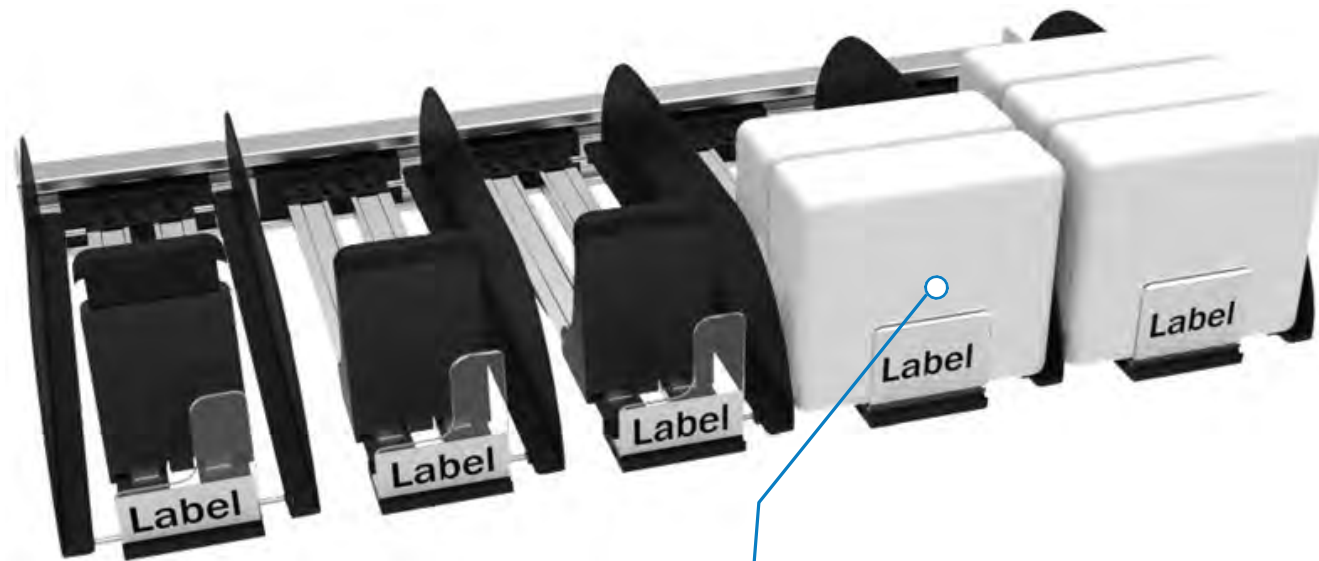

Toolless Construction

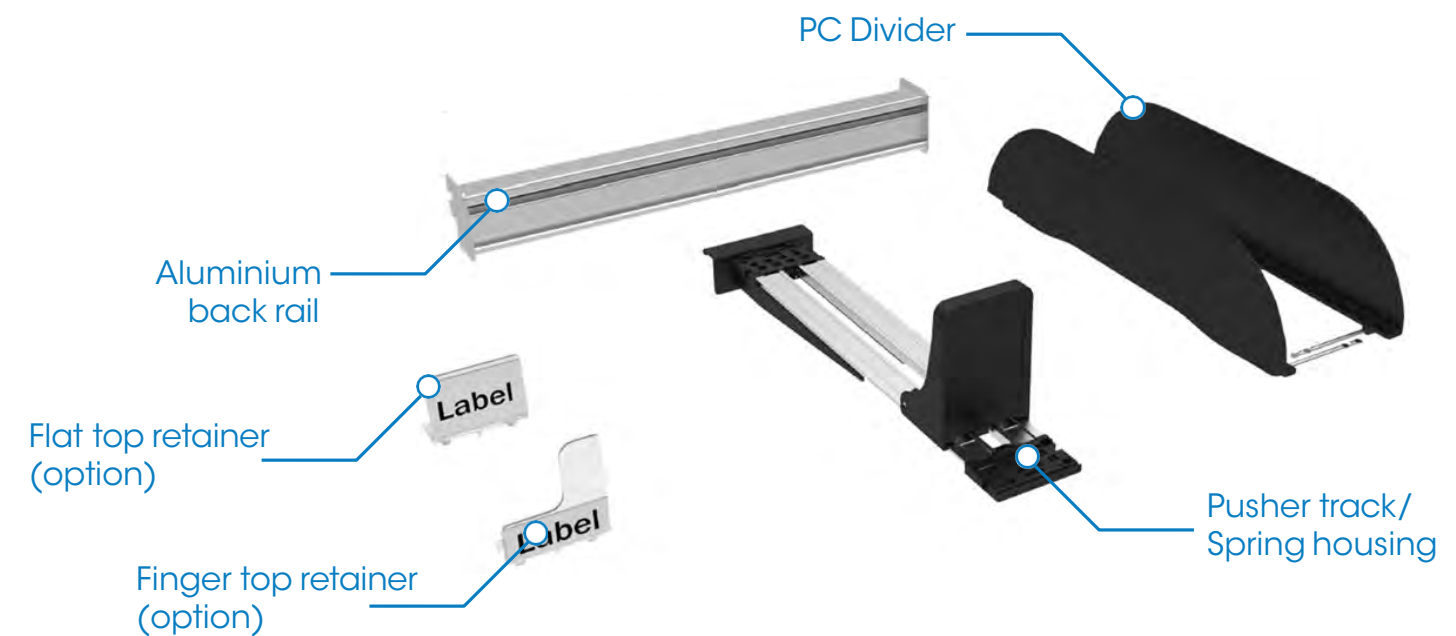

SHELF VERSION

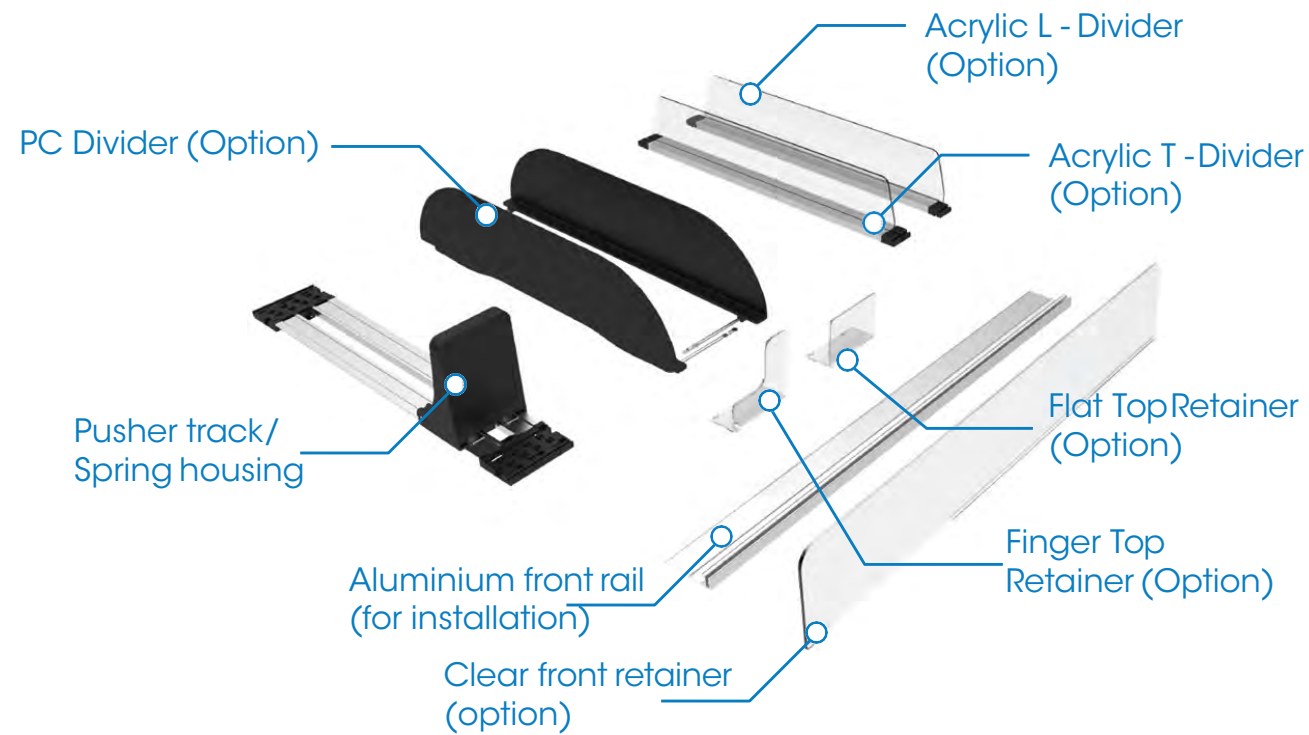

Introducing the VersaPusher, a versatile fronting merchandiser.

- Space management on shelves, in coolers and freezers
- Aluminium tracks deliver efficient fronting
- Durable construction
- Dividers easily adjust to suit 120mm - 200mm wide packages (Available as PC or Rail)
- Expandable pusher housing
- All components attach to front rail for easy installation and lane adjustment

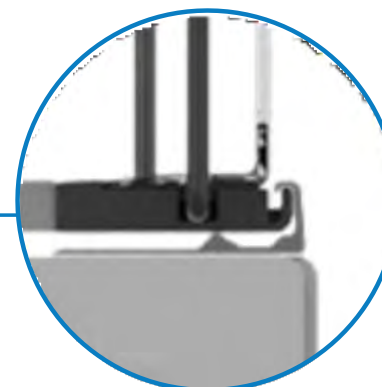
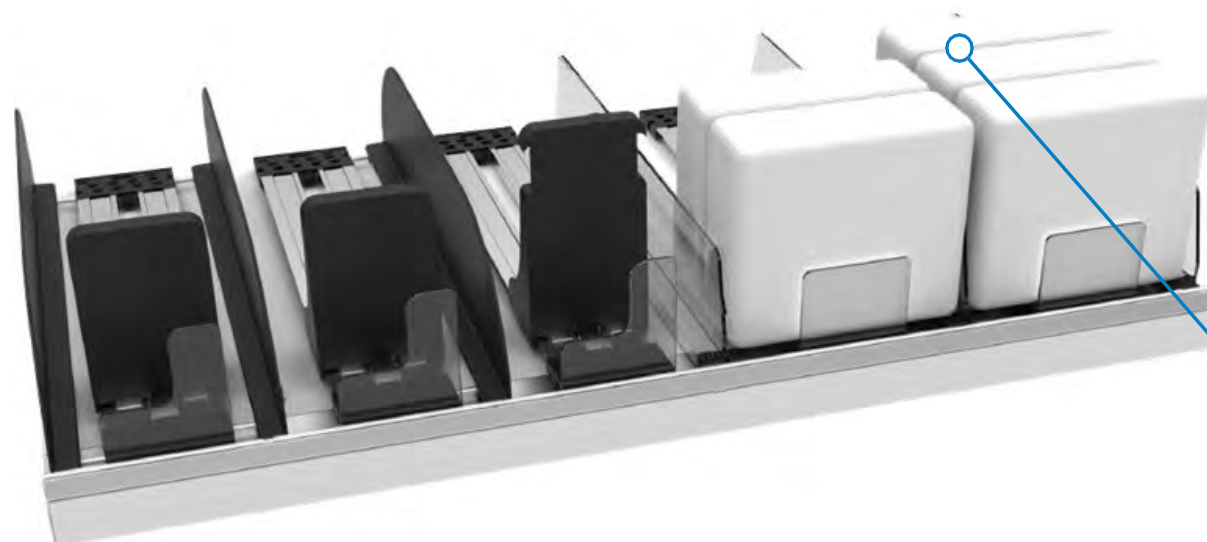

Toolless Construction

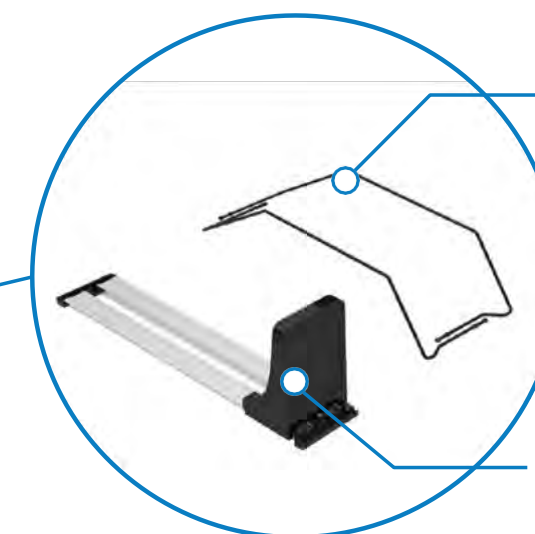

Rail Divider (Option)

Short End Cap Pusher track/
Spring Housing

Introducing the VersaPusher, a versatile fronting merchandiser.

- Space Management on shelves, in coolers and freezers
- Aluminium tracks deliver efficient fronting
- Durable construction
- Integrated divider (Track width or 30mm)
- All components attach to front rail for easy installation and lane adjustment

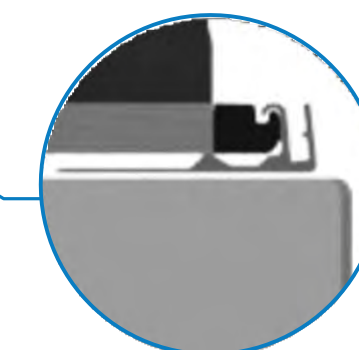
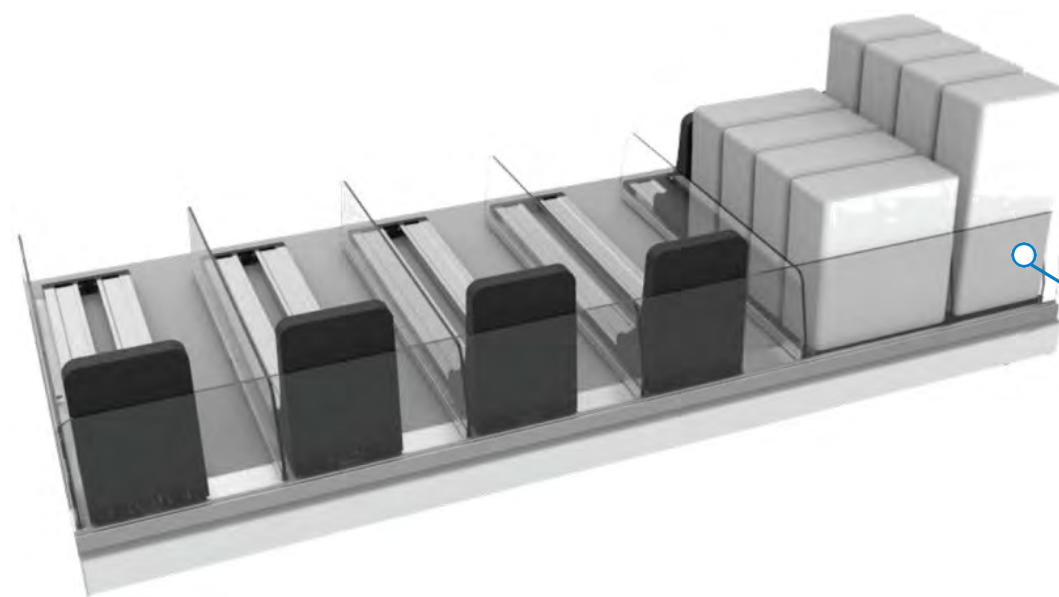
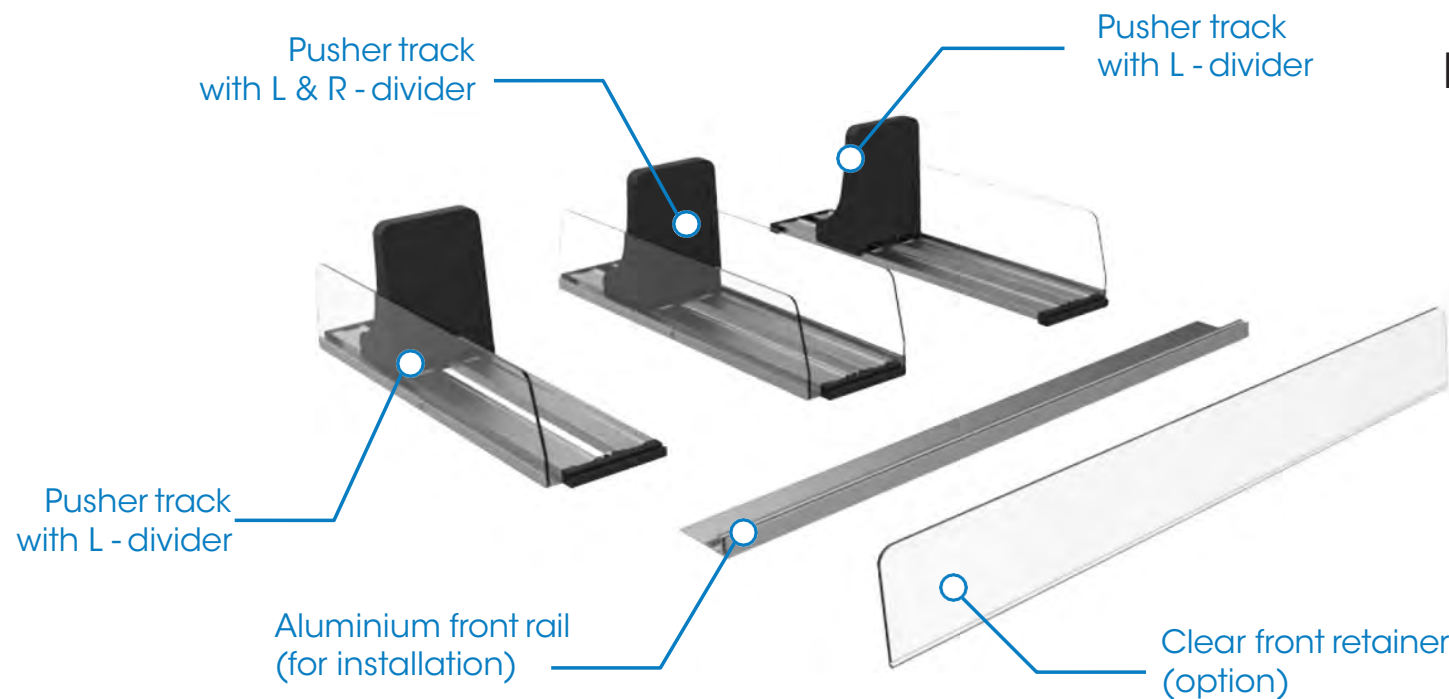

Toolless Construction

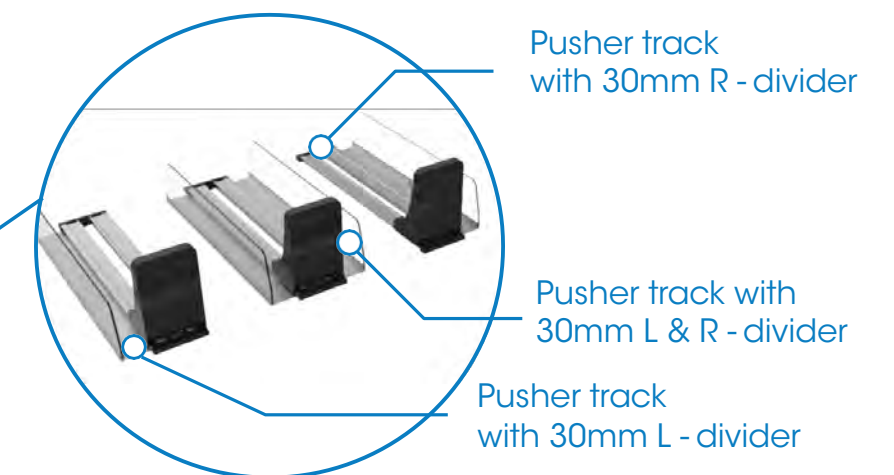

MICRO VERSION

Introducing the VersaPusher, a versatile fronting merchandiser.

- Space Management on shelves, in coolers and freezers
- Aluminium tracks deliver efficient fronting
- Durable construction
- Available with or without integrated divider
- Pushes products with minimum 13mm thickness to the front
- All components attach to front rail for easy installation and lane adjustment

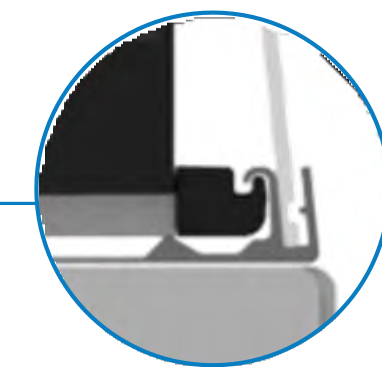
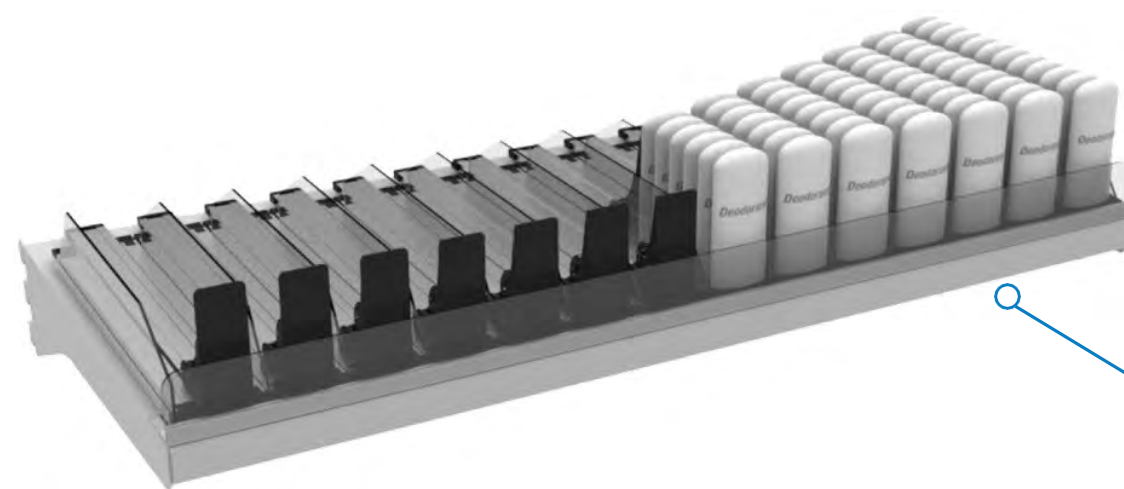
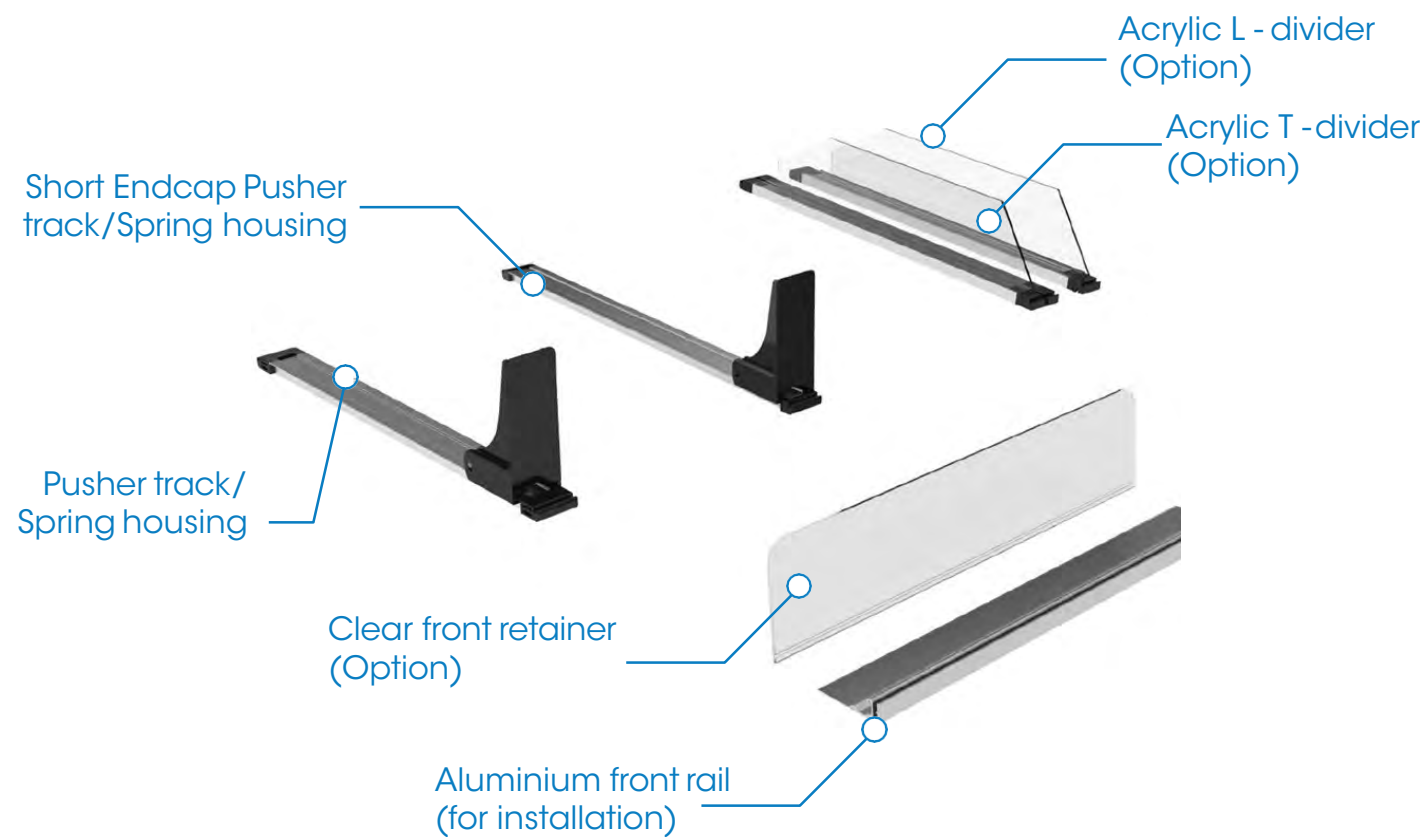

Toolless Construction

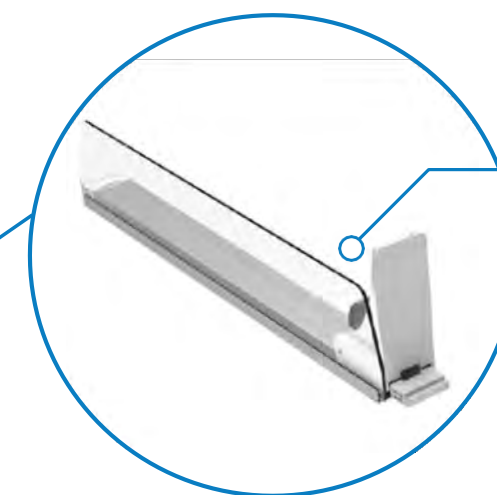

Pusher track with L - Divider

Custom Shelf Overlay Kits

Pre-assembled for quick install onsite

SPOS offers the pre-assembly and kitting of shelf merchandising systems which make on-site installs quick and easy. Dividers, pushers and category branding items can be pre-assembled upon a durable shelf overlay, allowing your merchandising team to simply place, stock and go!

Overlay Kits are available in a range of sizes, colours and assemblies. Adjustable systems are also available for retailers with varying shelf depths. Our design team can also help you out with custom graphics to suit your needs.



saves \$ on merchandising time instore



Universal Overlay



Custom Designs Available



Adjustable Versa-Pusher

Perfect organisation and product rotation

Perfect for any product size and style (bags, boxes, tubs, blister packs), The 'Versa-Pusher' System delivers additional facings, and its unique profile design ensures bagged product does not tear.

Expandable walls enable pushers to be used with a variety of packaging styles. Springs and riser components can be adjusted to suit a variety of product weights or any specialised product requirements.



expandable walls



pulls-out for excellent product rotation



Hook/ Prong Merchandising

Know what you need?

PERFORATED METAL



WIRE GRID



WOODEN PEGBOARD



CROSS BAR



SLATWALL



SLOTWALL



The requirement for space efficiency and product security for suspended products is fundamental to the extensive SPOS display merchandising hooks portfolio. We can provide you with hooks for all purposes and we offer a custom design division for those hook applications that cannot be met using standard products. Our stocked hooks will suit a variety of mounting options.

Choose From:

- Single Metal Hooks
- Flip Scan Hooks
- Loop Hooks
- Fast Back Hooks
- Hook Accessories
- Hand and Sell Solutions

How To Measure Length:

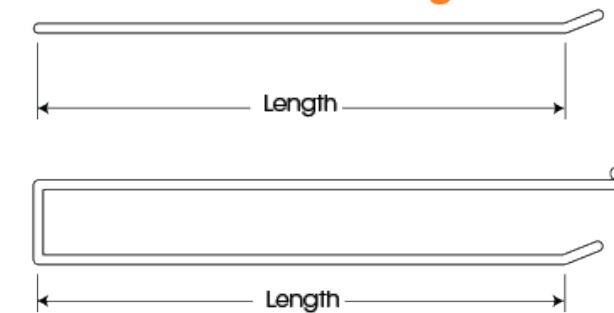

Custom Solutions

The SPOS design department will work with you to provide custom hang sell and hook solutions for your unique product. Call us today and speak to one of our customer service operators for more information.



Hook/ Prong Merchandising

ORGANISED - EFFECTIVE - PROFITABLE

Single Metal Hooks

The Single Metal Hook provides the simplest, most versatile solution for hook merchandising. There are various back/ hook length combinations available in various wire thicknesses.

Minimum quantities may apply.

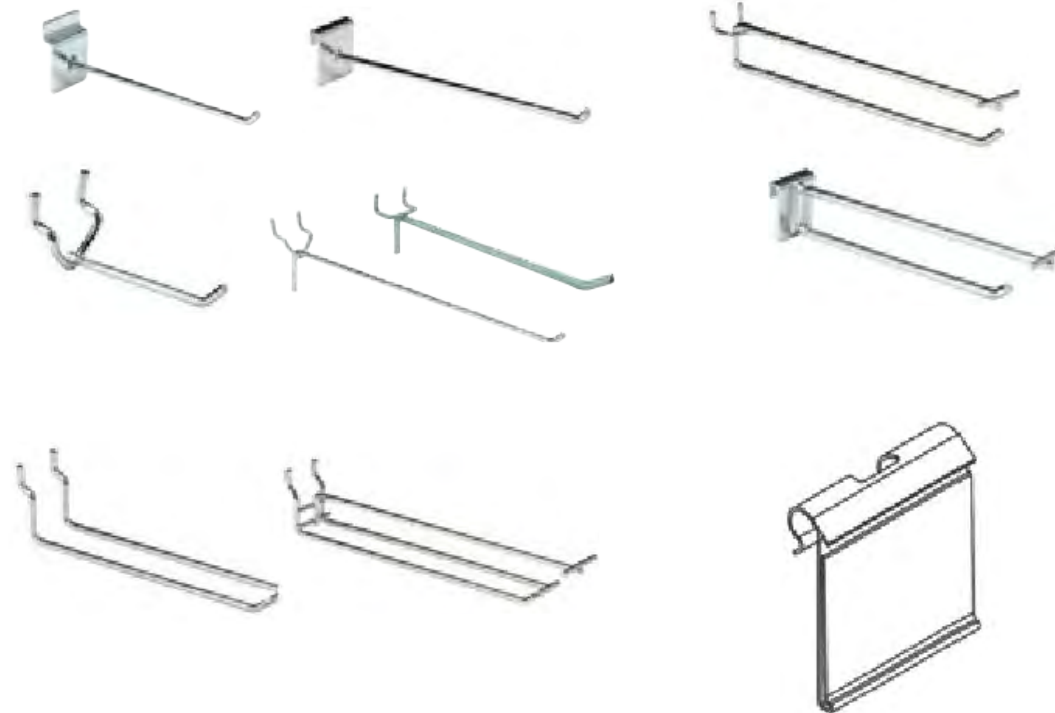

Loop Hooks

The Loop Hook is designed to maintain level display of sometimes off-balance products. The loop fits standard hang tabs on many products.

Available with or without Flipscan.

Fast-Back Hooks

The Fast Back Hook is a two part system with the removable mount designed to provide fast entry and easy relocation without disturbing existing product. This system is also useful in maximising vital product facing area as they can be fitted tightly against overhanging shelves and other shelf fixtures.



Inventory Control Clips

Keeps hook suspended merchandise up-front on pegboard hooks and establishes a re-order point for staff. Installed in a second without disturbing merchandise.

Available in three sizes.



Flip Scan Hooks

The Flip Scan Metal Hook is one of our most popular stocked lines. The lower hook hangs product and the upper part of the hook holds and displays a VIP flip ticket carrier. There are various different back/hook length combinations.

Flip Scan Label Holders

Flip-up label holders or VIPs are available in a range of sizes and colours and are commonly used in conjunction with our T-bar hooks to display pricing or product information. The ticket holder is mounted over the T-bar and conveniently flips up out of the way as the product is shopped.

Hang Sell Repairs

Rehanger
Keeps products on display and prevents mark downs. Invisible to the eye. Roll of 2,000

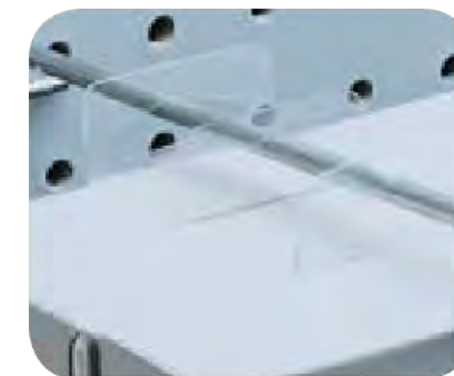

Hang Tabs

Hang Tabs with adhesive backing allow items to be displayed on peg hooks or sell strips to maximise in-store selling space. Hang Tabs can be used to hang, repair damaged packaging and reinforce header cards. Carrying weights shown as guideline only.

Testing is recommended to determine suitability.

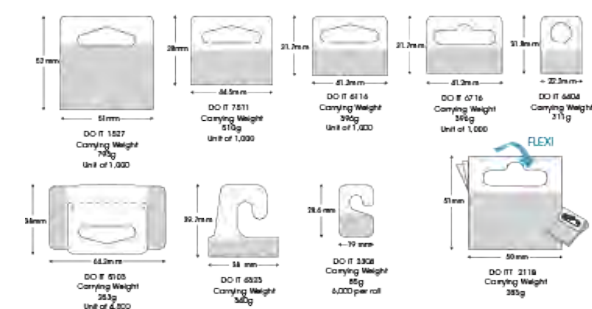

Anti-Sweep Hooks

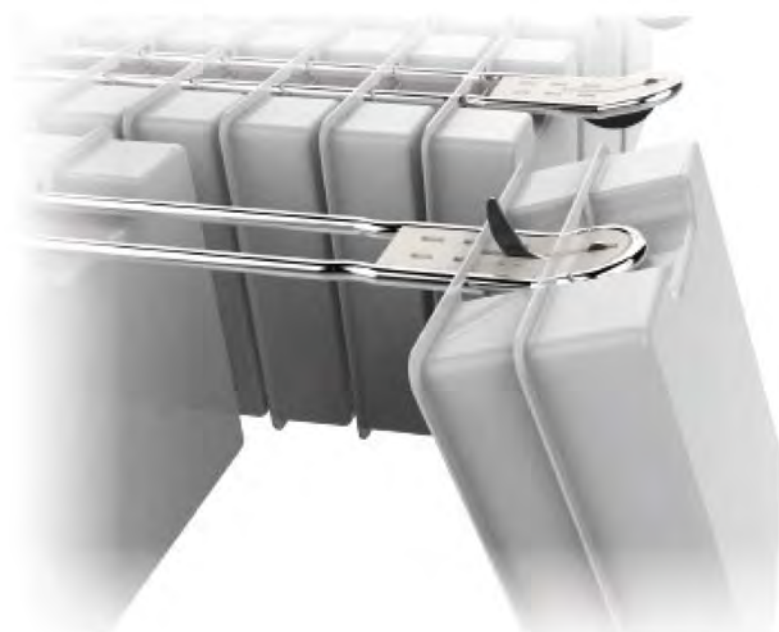

Available in a variety of lengths, and prong types suitable for different product applications.

Anti-sweep hooks are an effective means to prevent 'sweeping' of high-value products by allowing only one product to be removed from the hook at any one time. Simple designs ensure a cost effective, durable solution.

Features:

- Products can only be shopped one at a time
- can be fitted to most walls

Store Type:

Low / Medium Risk

Categories:
Various



Security Pusher dividers work along-side the flexroller divider mounting system, and are compatible with both traditional flexroller shelves as well as flat shelves with an integrated mounting mechanism.

The security dividers not only negate the use of shelf ready packaging, but provide an anti-sweep solution by utilising a pusher divider to 'dispense' only one product at any time. Upcoming developments enable a divider system that can be adjusted at store-level for varying product height & depths.

Features:

- Flex Roller is already ranged by Procurement and has a proven track record
- Secure solutions whilst maintaining ease of shop-ability
- Keeps category clean and tidy
- Adjustable for varying product types and sizes
- Best compatible with pull-out shelves for easy re-stocking

Store Type:

Low / Medium Risk

Categories:

Shampoo, Vitamins, Supplements, Medicinal



Adjustable divider system with integrated security door, ensuring two handed functionality, enabling only one product to be shopped at a time. System can be installed into existing FlexRoller set-ups maximising ROI, and protecting profits instore.

Features:

- Used in conjunction with flexroller or pusher systems
- Lifting hatch can be customised at store-level and repositioned to suit multiple product types, sizes and POG layouts
- Lift-hatch enables only one product to be taken at any one time.
- 2 handed operation required

Store Type:

Low / Medium Risk

Categories:

Shampoo, Vitamins, Supplements, Medicinal, Liquor

The Dispensing Display is a gravity feed solution that allows simple product selection whilst keeping inventory both safe from sweeping and well presented.



Before

After

15

Features:

- Optional clear graphic sleeve for targeted messaging and product information.
- Clear acrylic front provides good product visibility for easy stock selection and allows staff to quickly identify out of stocks.
- Can be produced in any colour.
- Fixing bracket can be developed to secure unit to either the pegboard, outriggers or shelf.
- Current design can be developed to incorporate a lockable front panel that can only be accessed by store staff.

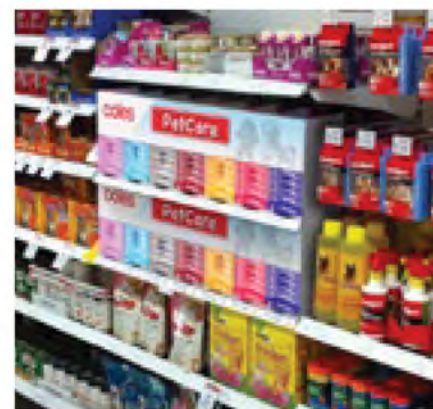

Store Type:

Any Store Type

Categories:

Pet Health, Gum, Nicobate, Batteries, Razor Blades



The Vitamins Slow Release System comprises a 'slow release' pod system in three sizes to accommodate the range. Access to product is limited by the casing and the slow release pusher will dramatically slow 'sweeping'.

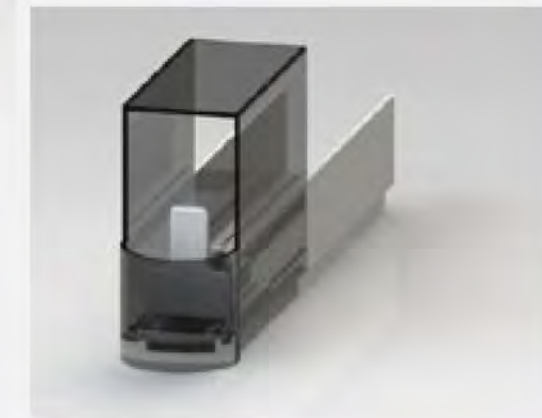

Store Type:

Low / Medium / High Risk

Categories:
Vitamins

Perfect organisation and presentation at the shelf



Sellstrip 12 Station

Plastic molded 12 station sell strip with header is a popular reusable style generally available in black or white.

Custom colours available on request. Minimum order qtys may apply.

Adjustable Impulse Strip

Plastic molded strip with adjustable hook heights means that it is suitable for a variety of product sizes and can be adjusted when new product is to be swapped over.

Lightweight design and a series of mounting and promotional additions are also available. Please chat with our sales team for samples and demonstrations.



Re-brandable Impulse Strip Kits

Plastic injection molded 5 station sell strip system which can be completely re-branded through the application of cost effective prints. Hooks, clips and various mounting components available.

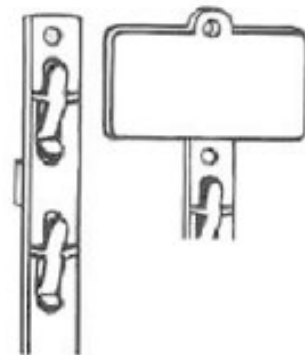

Double Duty Clip Strip

A versatile Clip Strip that's re-usable and lets you connect strips together. Product clips also double as hooks. Attach with adhesive or by hanging hole (for use with 'S' Hooks).



Poster/ Ticket Frames & Accessories

ORGANISED - EFFECTIVE - PROFITABLE

Plastic frames are available in a wide range of colours and sizes. If not listed please contact the SPOS customer service team regarding colours and sizes you may require. Minimum order quantities may apply on non stock items.



Available Sizes

| | |
|----------------------------------|-----------|
| A1 frame fits standard page size | 594x841mm |
| A2 frame fits standard page size | 420x594mm |
| A3 frame fits standard page size | 297x420mm |
| A4 frame fits standard page size | 210x297mm |
| A5 frame fits standard page size | 148x210mm |
| A6 frame fits standard page size | 105x148mm |

| Colours |
|----------|
| CLEAR |
| BLACK |
| WHITE |
| GREY |
| GREEN |
| BLUE |
| MID-BLUE |
| RED |

PVC Frame Inserts

Clear PVC inserts are available for use with our range of frames. They provide protection and stability for your graphics. Please ask our customer service team for codes and product information.

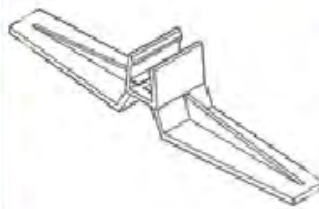

Upright Table Stands

Table stands for displaying frames at right angle to table. Compatible with our standard poster frame range.

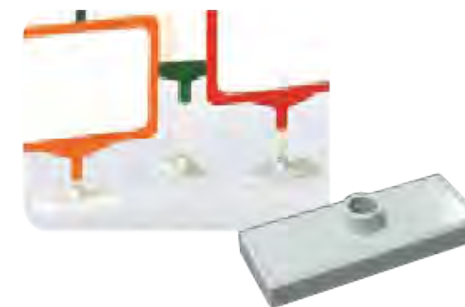

Magnetic Base

Heavy duty magnetic base fits 12mmØ shafts. Size 100x40mm

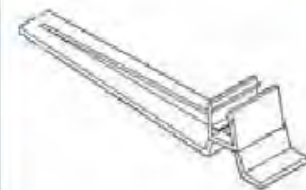

Angled Table Stands

Table stands for displaying frames at right angle to table. Compatible with our standard poster frame range.



Floor Standing Showcard Stands

Two part stands consisting of a heavy steel base with a screw in shaft. Stands are available in several heights and are powder coated in a range of standard colours. Suitable for displaying up to A2 sized plastic frames.

Frames & Banner Systems

ORGANISED - EFFECTIVE - PROFITABLE

Mitered Corner Snap Frames

Snap frames provide a simple polished look. Manufactured from natural anodised aluminum, these snap frames come fully assembled with mounting fixtures. Snap frames are available with mitered (M) or rounded (R) corners in standard sizes from A0 to A4.

For other sizes and custom colours please contact us.



Rounded Corner Snap Frames

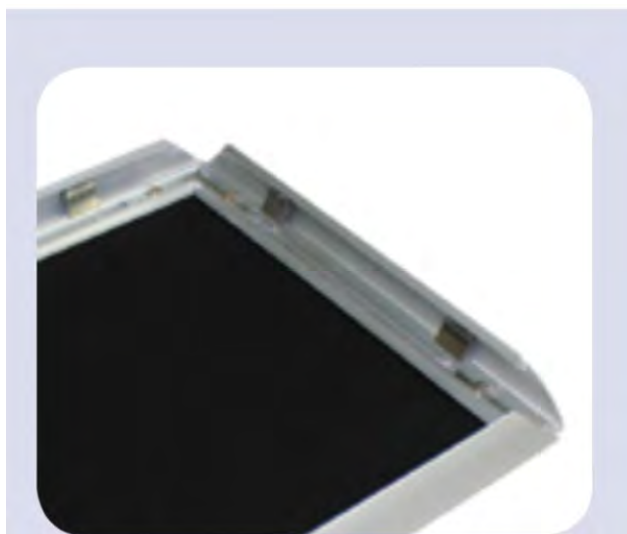

The spring loaded sides make them easy to 'snap' open and shut when changing graphics and they come standard with a non-reflective PVC cover to protect your images.

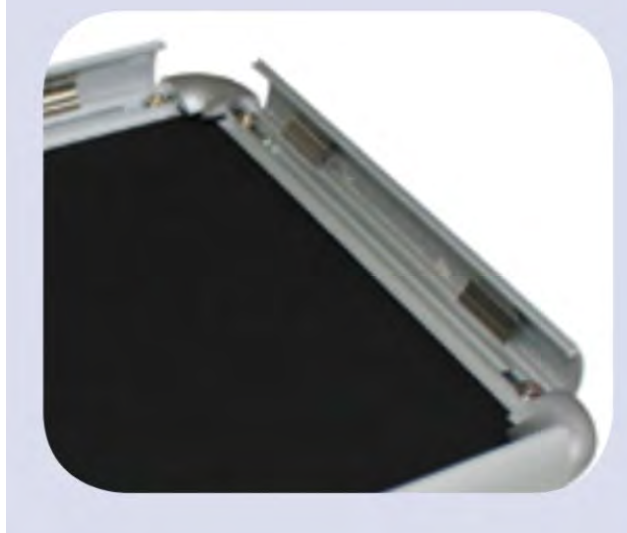

Gripper Poster Holders, Banner Rail & Poster clips

In store poster and sign hanging has never been easier with our range of poster hanging systems. They are easy to use and ideal for hanging all different sizes of posters, banners and signs including large format prints. SPOS can also supply aluminum profile systems for a more polished look.



Poster Hanging Accessories

SPOS has a comprehensive range of accessories for hanging or mounting posters, displaying tickets and signage and constructing your point of purchase displays. Our years of knowledge and experience mean we can assist you in choosing the best options whatever your project may be.

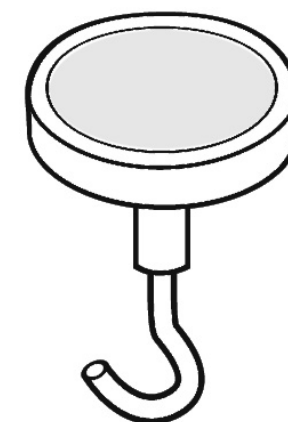

Complete Signage Solutions

ORGANISED - EFFECTIVE - PROFITABLE

In-store signage is an essential marketing tool for customer communication and engagement. Whether you are displaying new product, sale offers, seasonal promotions or product information SPOS has a sign or ticket display system that will work for you.

Snap Frames



Poster Frames



Floor Stands

Klick Frames



Sign Arms

Sizes

Poster Frames and Snap Frames are available in sizes from A1 to A6. Most sizes can be ordered in both Portrait and Landscape formats.

Accessories

A wide range of accessories are available, including solutions for floor and shelf mounting or suspension.



Rotating Aisle Display

In-store promotions and product information can be a huge boost to your business triggering above the line advertising recall in-store, introducing new products or promoting sale items. The RAD is also an effective tool in categories where you need to provide shoppers with product information to guide their purchase decisions.

UNIT SPECIFICATIONS

Height: 600mm Width: 130mm Depth: 130mm
Fabricated metal powder coated body and brackets with 3 PVC insert graphic covers. Graphic panels sold separately. Full in house graphic design service available contact the SPOS customer service team for further information.

Signage Systems

ORGANISED - EFFECTIVE - PROFITABLE



Sign Holders



Acrylic Displays



Poster Rails



Hanging Systems

Point of Sale Accessories

Everything you need to get attached....

SPOS has a comprehensive range of accessories for hanging or mounting posters, displaying tickets and signage and constructing your point of purchase displays. Our years of knowledge and experience mean we can assist you in choosing the best options whatever your project may be.



Wobbler Strip

Patented Wobbler Strips add lively motion to any display. Adhesive at both ends secures signs firmly to strip and to shelf.



Deko Spring

A durable spring lets your message wobble for a maximum impact. Adhesive both ends secures spring to cash registers, shelves etc.



Clip-on Sign Holders

Table stands for displaying frames at right angle to table. Compatible with our standard poster frame range.

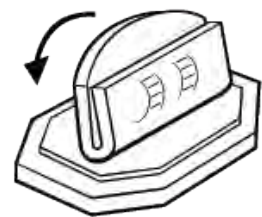

Adjustable Counter Top Sign Holder

Table stands for displaying frames at right angle to table. Compatible with our standard poster frame range.



TWIST-POP

Twist-POP has adhesive end tabs. Attach one end to flat surface and the other to the sign and give it a twist into the position you want.

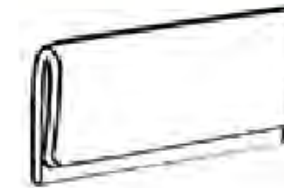

Ticket Stabiliser Clip

Clips onto datastrip to attach shelf talkers and



Neptune Clip

Insert pointed end of clip into corrugated displays

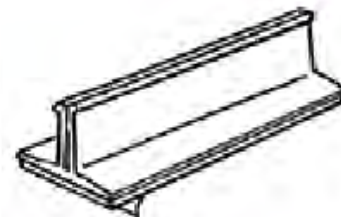

Card Holder

Card holder allows materials up to 3mm thick to be slid easily in and out of grip. Permanent adhesive base attaches to most flat surfaces.



Shoe Clip

Can be clipped over shoes or other items up to 9mm thick. Adjustable angle for maximum viewing opportunity.

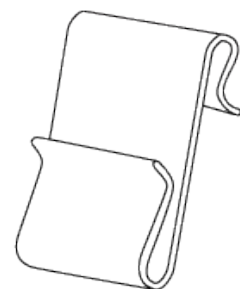

Wing Clips

Available in a variety of shapes, sizes, materials and colour options



Viking Clips & Rivets

A variety of plastic clips and attachments for various display constructions

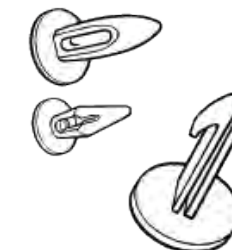

Dart Clips and Thumb Snaps











A variety of plastic clips and attachments for various display constructions

Point of Sale Accessories

ORGANISED - EFFECTIVE - PROFITABLE

Super Grips

Supergrip sign holders have soft plastic fins that grip your POP materials holding signs and tickets firmly in place even in high traffic areas. Standard grips hold materials up to 2.5mm, while heavy duty grips hold between 3-6mm thickness materials. All Supergrips are made from clear polypropylene and/or PVC materials. Custom Lengths are available for some items on indent order, minimum order quantities may apply

| shape | Description | shape | Description | shape | Description |
|--|--|---|--|---|--|
|  | SUPERGRIP WITH SPRING HINGE Sign holder with flexible hinge allowing sign to move if bumped then return to original position. Wide base provides added stability and attaches to fixtures with permanent adhesive. |  | FLIP-UP SIGN HOLDER Rear part clips over datastrip while supergrip front firmly grips shelf talker. Hinge allows ticket to swing up out of way. |  | SUPERGRIP WIDE BASE SIGN HOLDER The wider base on these sign holders offers greater stability and adhesion to surfaces. Available in three lengths 25mm, 75mm and 150mm. |
|  | SUPERGRIP HEAVY DUTY SIGN HOLDER Suitable for clipping Klick Frames over wire baskets, small tubes and containers. Available in two sizes to fit 10mm or 20mm. |  | FLAG SIGN HOLDER Supergrip firmly grips datastrip and holds signs securely in right angle flag position. Hinge allows ticket to swing up out of way. |  | SUPERGRIP PARALLEL HANGING SIGN HOLDER Attaches to any flat surface with permanent adhesive tape. POS material is secured parallel to clip base allowing it to hang down freely on vertical surfaces |
|  | SUPERGRIP COUNTER SIGN HOLDER These low profile sign holders are 25mm long and have an adhesive base to attach them to any flat surface |  | FLIP-UP FLAG SIGN HOLDER Supergrip firmly grips datastrip and holds signs securely in right angle flag position. Hinge allows ticket to swing up out of way. |  | SUPERGRIP WIRE FLAG SIGN HOLDER Clips over up to 5mm wire shelving or baskets holding ticket in right angle flag position. |
| | |  | SUPERGRIP WIRE CLIP-ON Clips over up to 10mm wire shelving or baskets holding ticket in parallel position. |  | SUPERGRIP H CLIP Clear PVC clip 25mm length great for connecting panels up to 2mm thick. Can be used vertically or horizontally. |

Suction Cups

Versatile solution for fixing promotional items to glass, metal, acrylics and other smooth surfaces.

| shape | Description | shape | Description | shape | Description |
|---|--|---|---|---|---|
|  | MUSHROOM HEAD SUCTION CUP Simple design allows hanging of signs with holes or grommets. Specs: 45mm diameter cup made from clear vinyl |  | PLASTIC THUMB TACK SUCTION CUP Mushroom head style suction cup with plastic thumbtack to secure signage firmly in place. Specs: 45mm diameter cup made from clear vinyl with plastic tack |  | SUPERGRIP SUCTION CUP 90° & 180° Supergrip holding power with no mess suction cup mounting. Holds ticket at 90 or 180 degree angle. Specs: Clear PVC grip with 25mm or 45mm vinyl cup |
|  | METAL HOOK SUCTION CUP Metal hook is a one-step versatile solution for hanging materials with small holes. Specs: 45mm diameter cup made from clear vinyl with metal wire hook |  | LARGE SUCTION CUP Two way mounting holes make this super suction cup suitable for a multitude of hanging and mounting applications. Spec: 85mm diameter cup made from clear vinyl |  | SUPERGRIP SUCTION CUP 3D SIGN HOLDER Create quick and easy 3D signage to attach to any smooth surface. Supergrip holders suitable for materials up to 2mm thick. |

Point of Sale Accessories

ORGANISED - EFFECTIVE - PROFITABLE



Jet Wires

Table stands for displaying frames at right angle to table. Compatible with our standard poster frame range.
Colour: Transparent only



Double End C Hooks

Versatile nickel plated wire C hook provides a robust set length hanging option suitable for heavier hanging displays. Available in standard and heavy duty wires at various lengths



Wire Ceiling Hangers

Simple metal wire clip to attach to grid ceilings



Twist-on Clips

Twist-on attachment for suspended ceiling grids. Can easily be removed and repositioned as required.



Snap Ring

Versatile snap rings used for numerous display opportunities. Available in various sizes, Metal or plastic



Small Wire 'S' Hook

Durable metal 'S' Hook for attaching chains and Jet Wires to ceiling fixtures.



Large Wire 'S' Hook

Large 'S' Hooks are useful for attaching sell strips to perforated shelving.



Hanging Buttons

White plastic buttons with adhesive backing. Single button supports up to approx 450g. Double button supports up to approx 1kg. Colour: white



Adhesive Hook

Small plastic hook with super strong adhesive base 25x25mm
Colour: White



Velcro & Mag Tape

Various materials available for attaching promotional items to store fixtures. Various widths, lengths, roll sizes available depending on application.

Point of Sale Accessories

ORGANISED - EFFECTIVE - PROFITABLE

Super Grips

Locking straps are used to secure sell strips and signage to wire baskets. Available in four styles in various sizes. All straps are made from flexible plastic nylon.



Cable Ties

Smooth finish strap that adjusts to desired size and locks securely.
Sizes Available: 4, 5.5, 7, 11 and 12 inches

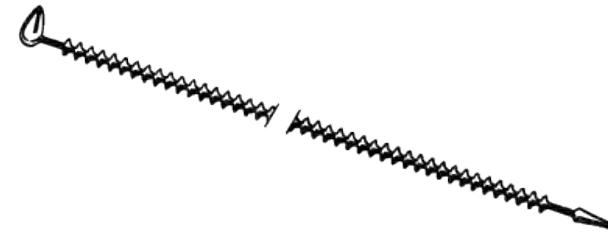

Securatives Locking Strap

Easy to use. Just wrap around fixture, insert pointed end into fixture and pull tight.
Sizes Available: 5 and 8 inches



Ladder Locking Strap

Adjustable notched strap makes it easy to vary locking lengths.
Sizes Available: 7 and 11 inches



Releasable Locking Strap

Can be used over and over again with release tab. Simply press tab to remove tie.
Sizes Available: 6, 8 and 9 inches



Freestanding Brochure Holders

Manufactured from durable crystal clear plastic, these brochure holders are an economical choice with an attractive contemporary design. Suitable for freestanding on counter tops and shelves, or any flat display area.



Mountable Brochure Holders

These brochure holders have a flat back and base that can be attached to the wall or other flat surfaces using the mounting holes provided or with double-sided tape.

Menu Holders

Simple and effective method of displaying graphics and information. Standard freestanding vertical or sloping profiles, menu holders are an essential marketing tool for displaying single or double-sided material. Items listed are portrait style but landscape format are also available.



sloping



vertical

Off Location Products

ORGANISED - EFFECTIVE - PROFITABLE



Wire Dump Bins

Suitable for short or long term displays, our durable wire dump-bins are smart, light-weight and easy to assemble. Wire mesh bins feature an adjustable shelf and the bins can be folded flat when not in use.

Available in Black and White



Cardboard Display Bins

Simple, effective and economical, cardboard floor bins are a good choice for short term promotions and stock clearances. For added impact these corrugated cardboard displays can be printed with your sales message or used in conjunction with our poster frames and display accessories.



Re-Brandable Display Unit

Retail approved solution which can be quickly and easily re-branded for in-store activations and promotions.



Portable FSU

Re-brandable FSU with uprights to support shelves, and peg-board backing for hang-sell retail. Customised variations available on request.

Q-motive merchandising system

ORGANISED - EFFECTIVE - PROFITABLE

The advantage of Q-motive is to entice shoppers to purchase while waiting in line.

The sleek modular system enables you to have a range of merchandise from confectionery, snacks, magazines and newspapers, to seasonal promotions, Valentine's Day, Easter, Winter Remedies, Mother's Day, Father's Day, Summer offerings, Christmas promotions and many other impulse lines !

Q-motive merchandising system is made up of a range of easily constructed modular units, and when put together it provides a barrier system which directs the flow of shoppers at the front end of stores.

The advantage of Q-motive is to have a range of merchandise including confectionery, magazines and newspapers, snacks and other impulse lines which can be displayed while the shoppers are waiting in line at the front end of store.



The Qmotive system have been proven to lift sales of these items by over 40%

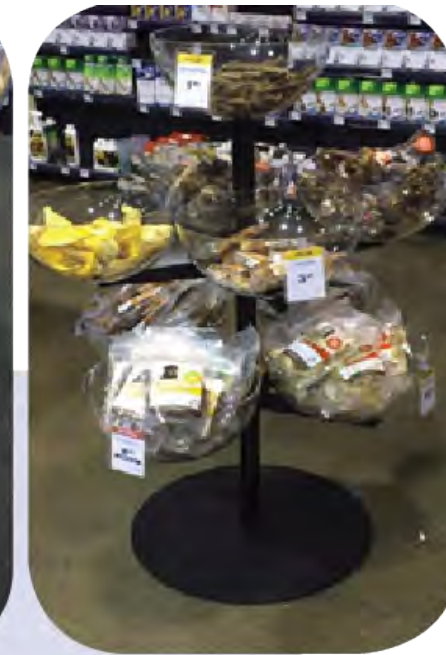

Easy to customise and fit in any retail environment. Custom attachments and colours available on request



A wide variety of merchandising can be incorporated into the system



Impulse Systems

ORGANISED - EFFECTIVE - PROFITABLE



FlexRoller is a universal shelf management system that delivers a wide range of tangible benefits to retailers, products and shoppers. It keeps products of all sizes and weight always front-facing on gondola shelving in all channels.

The FlexRoller system carries a 5-year limited warranty and the main benefits are:

- Sales lift in all categories
- Easy to shop the products on the shelf
- Labor savings related to shelf maintenance and re-stocking
- Enhanced presentation of products on the shelf
- Space management is easy due to flexible lane adjustment
- Planogram compliance is easy to implement



Perfect product facings everytime



Shelf Overlays



Fridge Shelves



Pull-out Shelves for easy re-stocking

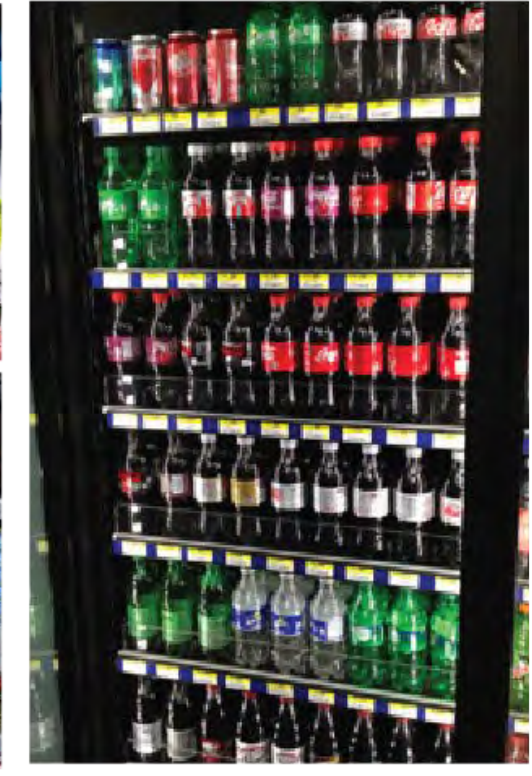
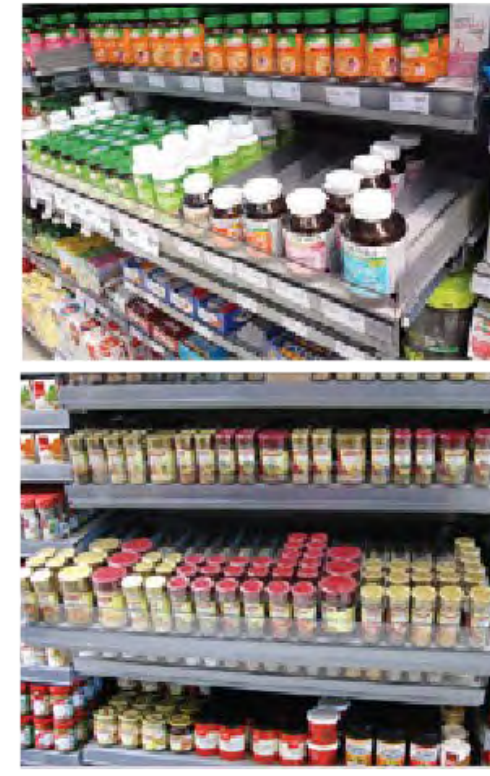

Overview:

FlexRoller shelves are customized to suit any application:

- Grocery/ Supermarket - ambient shelves
- Convenience Stores - cold vaults and open chillers
- Suited for all package types

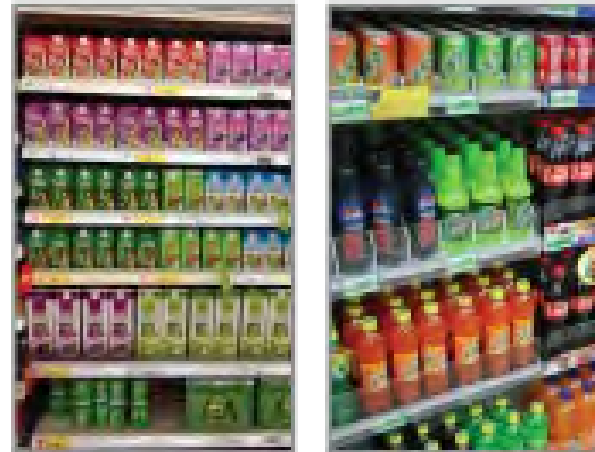

Features:

- Products are always fronted to the shelf edge
- Lane dividers are easily adjusted to suit any package type
- FlexRoller shelves will last a minimum of 5 years in the marketplace
- Activation of top and bottom shelf
- Shopper marketing where it needs to be - at the shelf
- Fits to many product categories



Results:

- Sales increase delivered through improved product presentation
- Labor savings because less time is needed to restock or organize a category
- Planogram compliance is achieved by quick and easy divider changes to fit any shelf configuration

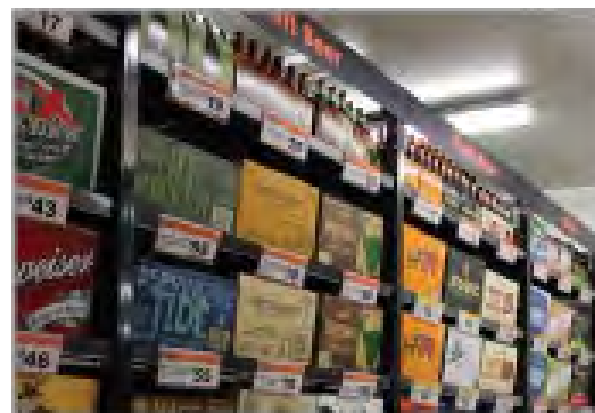

Sales Lift

Retailer scanner data confirms that FlexRoller installed stores outperformed control stores by 6%.

Measured sales by month for current vs prior year.

Product fronting labor savings

FlexRoller saves up to 2 hours per day per store.

Labor time required for fronting and fixing the shelves.

Store Manager Feedback

Positive feedback from test locations.

- "Saves time"
- "No risk investment"
- "Superior product"

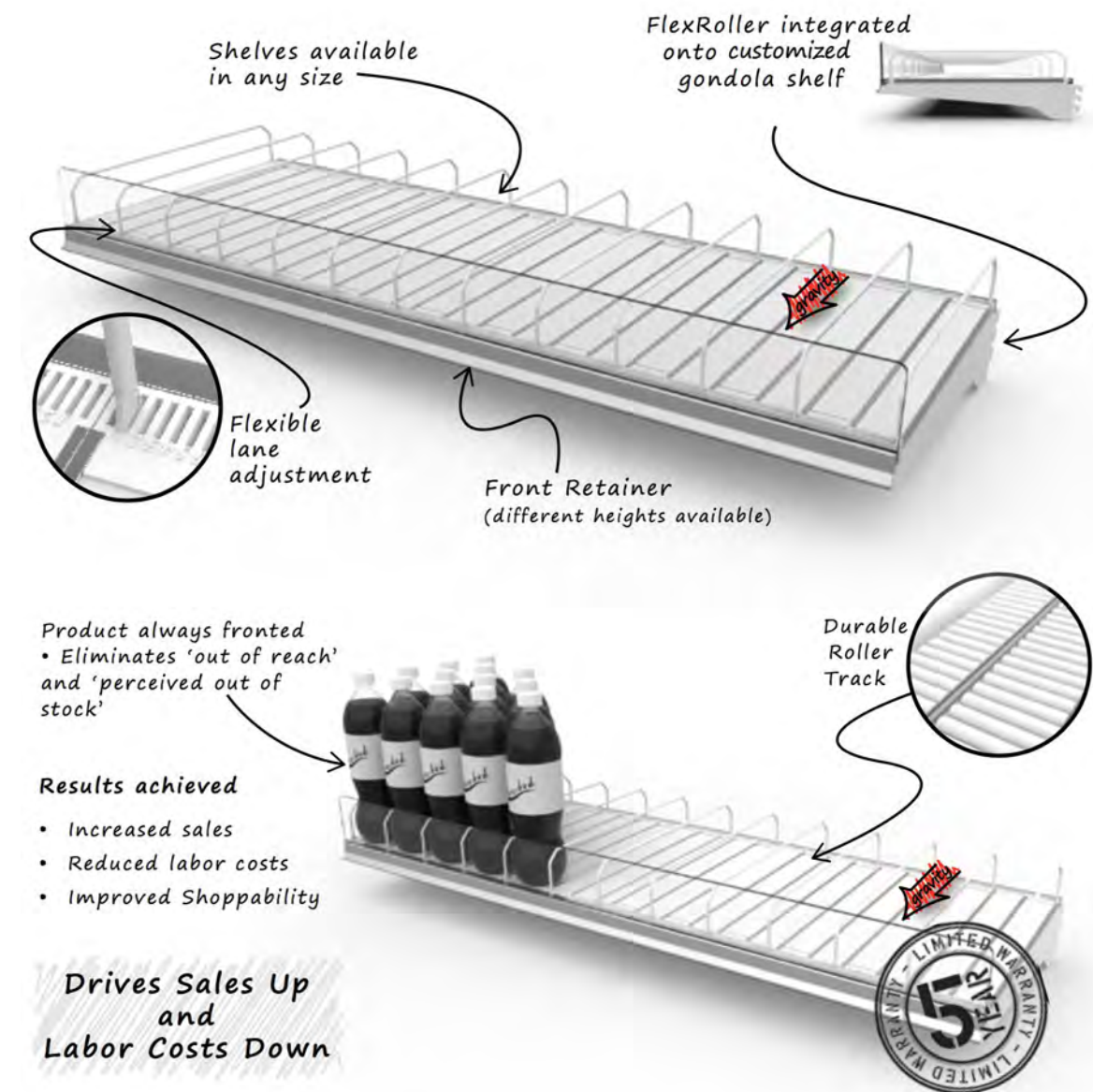

Drive sales with high-impact display solutions...



Off Location Displays

ORGANISED - EFFECTIVE - PROFITABLE

Combination freestanding units

Units developed to support combination of fridge/chiller merchandising with ambient merchandising and promotional. Units can be re-branded for various activations and retail environments. Adaptable for use across many product categories including FMCG, Liquor, Health and Beauty specialty stores, chilled pet food etc.



Rebrandable units for product sampling

SPOS have a range of bespoke and off the shelf re-brandable product sampling stands available to activate your products through live sampling, product testing and, in store theatre. Bespoke units are designed with ergonomic and retail display principals in- mind.

Sampling



Small Goods Merchandising

ORGANISED - EFFECTIVE - PROFITABLE

Pro-Shelf

SPOS offers a range of flexible POS systems suited to small goods merchandising. Ideal for deodorants, perfumes, small bottled goods etc. The Pro-shelf system brings organisation to the shelf. Combined with SPOS pushers and FlexRoller products, our in-house design team can tailor a solution to suite your product needs.

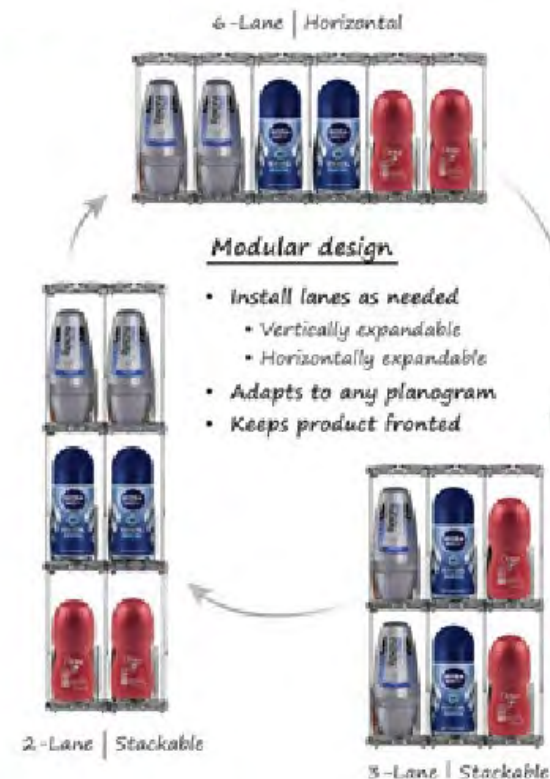

Tub-Sliders

Product merchandising modules ideal for round containerised products. Products lids are elevated for maximum brand facing and stock automatically front faces when product is shopped. These units are available in a variety of custom colours and sizes, are an ideal product merchandising solution for haircare, makeups, balms & gels etc.



Dispenser Systems

ORGANISED - EFFECTIVE - PROFITABLE



Merial - Flea Station / Category Dispenser Unit



How we delivered a premium brand experience



BRIEF

- Price Attack is a chain of nearly 100 franchised hair care outlets and salons.
- Fleet of stores were ageing and cost of fit-out and upgrades for franchisees was prohibitive.

PROPOSAL

- “Store in a Box” system developed by iCandy Creative. This allowed us to produce a single design that was scalable up or down due to the store footprint.

RESULT

- By simplifying the manufacturing process, and arriving at one design solution for the network, iCandy Creative reduced the cost of fit-out significantly*.
- Successful sales uplift recorded for stores refurbished with SIAB
- Enhanced customer experience reported via regular client feedback. Recent Feedback from an Area Manager

“Yesterday was an amazing success! We had such a great day, extremely busy with nothing but positive comments coming through from all of our customers.”

BEFORE



AFTER

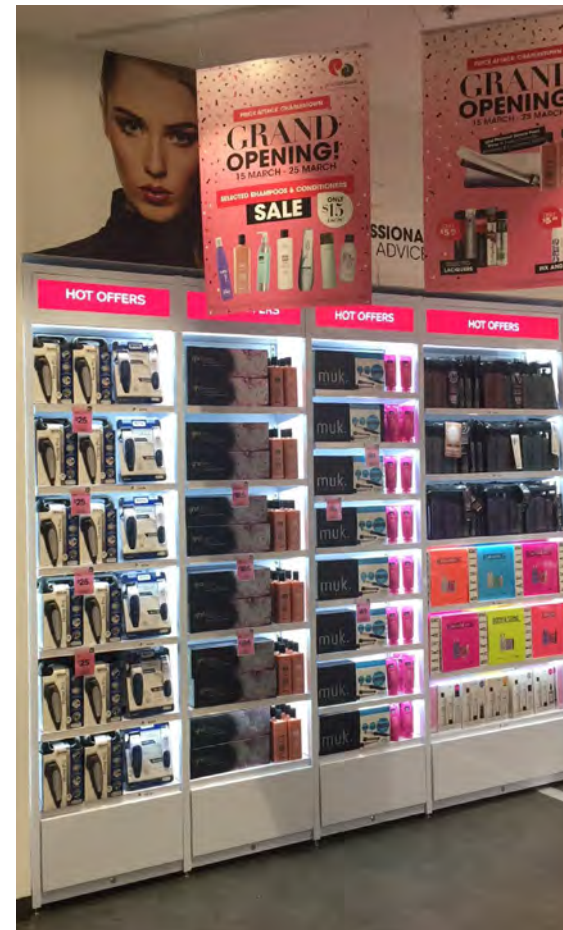
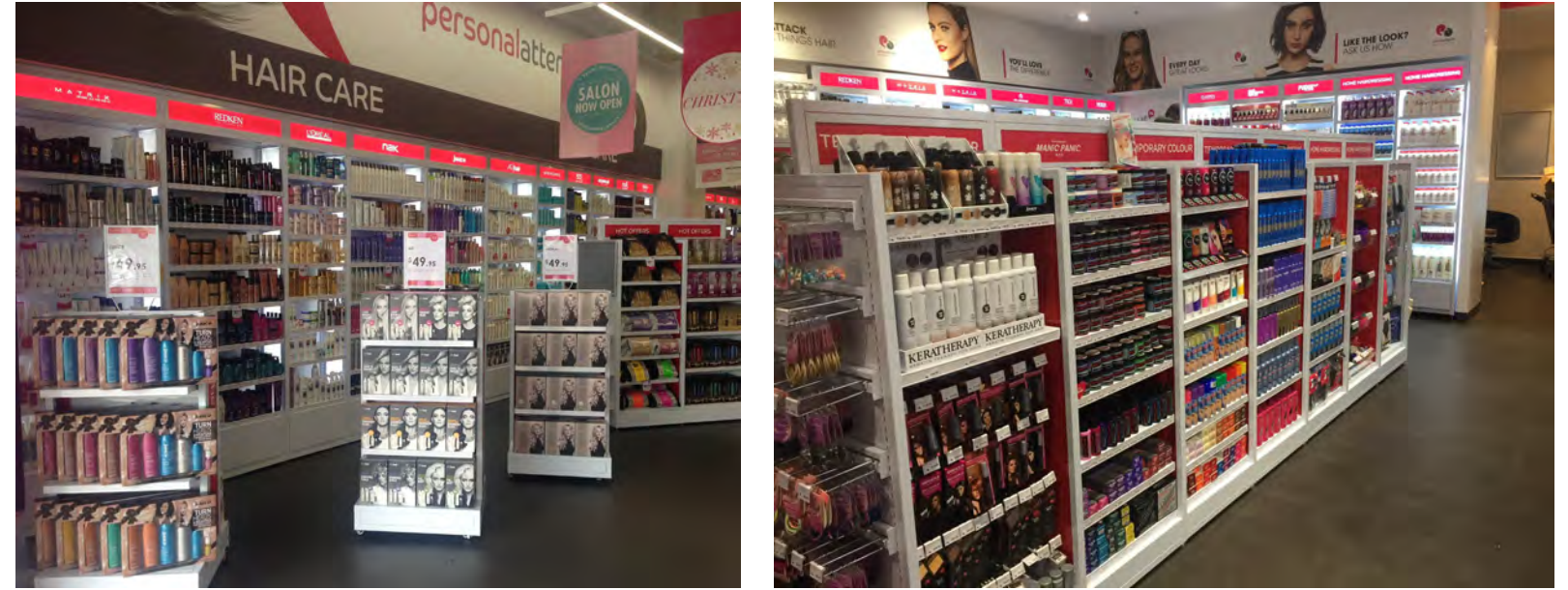

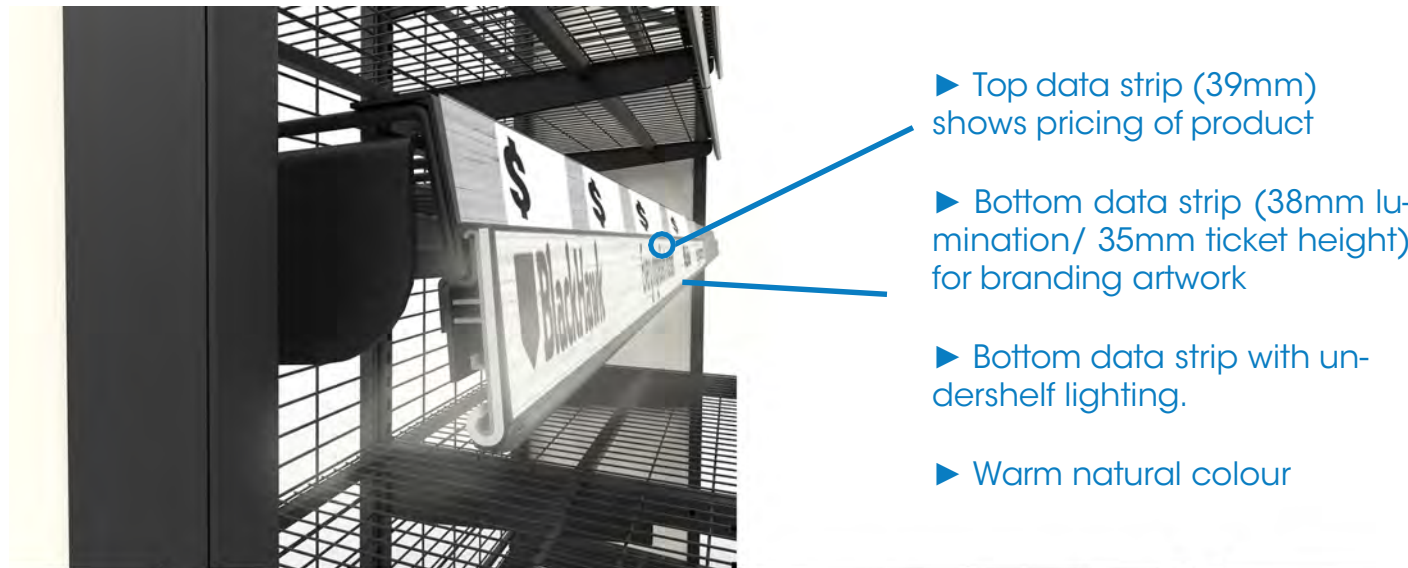

BRIEF

- BlackHawk real food movement is all about eating food that improves our health, happiness and longevity
- Design unit that will allow high stock holding, compact footprint, suitable for dog + cat for both, wet + dry food types, easily updatable signage for promotional activity, modular unit can be scaled from single 1-bay display to multiple 4-bay

PROPOSAL

- BlackHawk brand activation unit was designed with a of key features to ensure it stood out from other brands
- Lighting was introduced in a natural warm lumen (as opposed to a clinical white light) to ensure the “natural” aspect of the brand was maintained and delivered in store

RESULT

- Concept proposal received excellent feedback and led to a high number of veterinarian clinics becoming stockists of the BlackHawk range.
- Buy-in deals negotiated and over 400 units we produced for the entire Australian market
- A strong impactful brand presence has been achieved with the premium display units.



masterpet[®]

never met a pet we didn't get

Masterpet

PROJECT: Brand Activation Station MARKET: Retail

Display Stand Merchandising

CASE STUDY

Concept



In store



Client Feedback

“To say the job was ‘well done’ isn't giving credit to the incredible quality and attention to detail in the design”

Concept



BRIEF

- Masterpet were launching a new range of pet toys and wanted to cross merchandise with their existing
- Looking for a unit that will allow high stock holding, compact footprint, easy to change planogram, easily updatable signage for promotional activity.
- Original request for wooden display unit but budget didn't permit.

PROPOSAL

- Masterpet cardboard display unit was designed with key features to ensure it could have interchangeable side graphics and header, an additional new product highlighter and solid construction to last.
- Additional "seasonal promotion ideas" were presented in this instance Christmas to further highlight the adaptability of the unit.

RESULT

- Concept proposal received excellent feedback and led to a high number of pet stores taking on the new product range of toys.
- A funky impactful brand presence has been achieved with the solid yet practical and easy to assemble cardboard units.

Concept



In store



Concept



BRIEF

- Brand new range of handcrafted children's shoes designed by pediatric podiatrists
- Soft launch in time for Back to School 2018.
- SPOS were invited to design a display stand to help the launch.

PROPOSAL

- A dual sectioned interactive kiosk was designed which offered education around shoes buying for children based on the product attributes of the brand on one part, along with the chance to touch and feel the shoes and get professionally measured with the 'Skobi Fit Mat' on the other.
- Integrating large LED header panels and a full-size tablet into the display enabled parents and care givers the opportunity to purchase the shoes on the spot and have the shoes delivered direct to the home so no fuss carrying the pairs of shoes around during the rest of the day.
- Flexibility during design phase required due to client software issues.

RESULT

- Kiosk received excellent feedback along with the shoes themselves and led to a high demand for clinics to become stockists and receive a kiosk in time for Back To School 2019

Conceptual Sketches

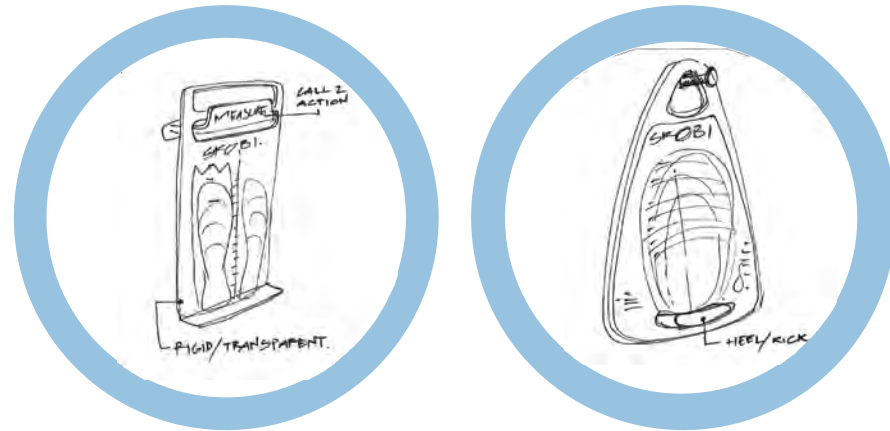

Production Photos



Conceptual Proposals





BRIEF

- Key client Price Attack approached SPOS to design and manufacture the store wide retail fixtures for a new male grooming concept launching in Australia – Tommy Gun's.
- Whilst the brief required the creation of bespoke display items for Tommy Gun's, an important design consideration was to retain the benefits and functionality of the existing Price Attack Wall Bay system but tailored to the theming of Tommy Gun's – a retro barber shop from the 1930s Chicago Golden Era.
- Timings were tight – just three months were given from brief to installation at the inaugural Australian store in Brisbane.

PROPOSAL

- In close collaboration with the client SPOS developed a suite of bespoke items to engage customers and showcase the Tommy Gun's product range. This included an angled cut throat razor rack akin to a museum display of heritage product, a backlit product glorifier, shaving brush rack, a unique clipper/trimmer unit taking design cues from mobile phone displays and a simple yet effective gravity feed unit for hair wax and pomades, affectionately called the 'tub slider'.

RESULT

- Month 1 sales were the best ever for a Tommy Gun's store worldwide and targets have been smashed in terms of store wide revenue and retail product sales.

'In close collaboration with Nigel, Jess and the SPOS / iCandy team, we developed a range of exclusive fixtures for the retail area of our Barbershop business. The response has been incredible, with overwhelmingly positive and enthusiastic feedback from our customers and suppliers alike.

The implementation of these displays has been fundamental to the success of this area of the business, with retail sales to date tracking at 50% beyond what we had originally projected.

We couldn't be happier with the design and execution, along with the dedication and high degree of attention to detail from everyone involved. No task has ever proven to be too difficult, and it has always been clear that Nigel and the team take just as much pride in the success of this project as we do.'

Sam Jarred, General Manager, Tommy Gun's Australia



How we developed a cutting edge solution for a barbershop retailer brand.





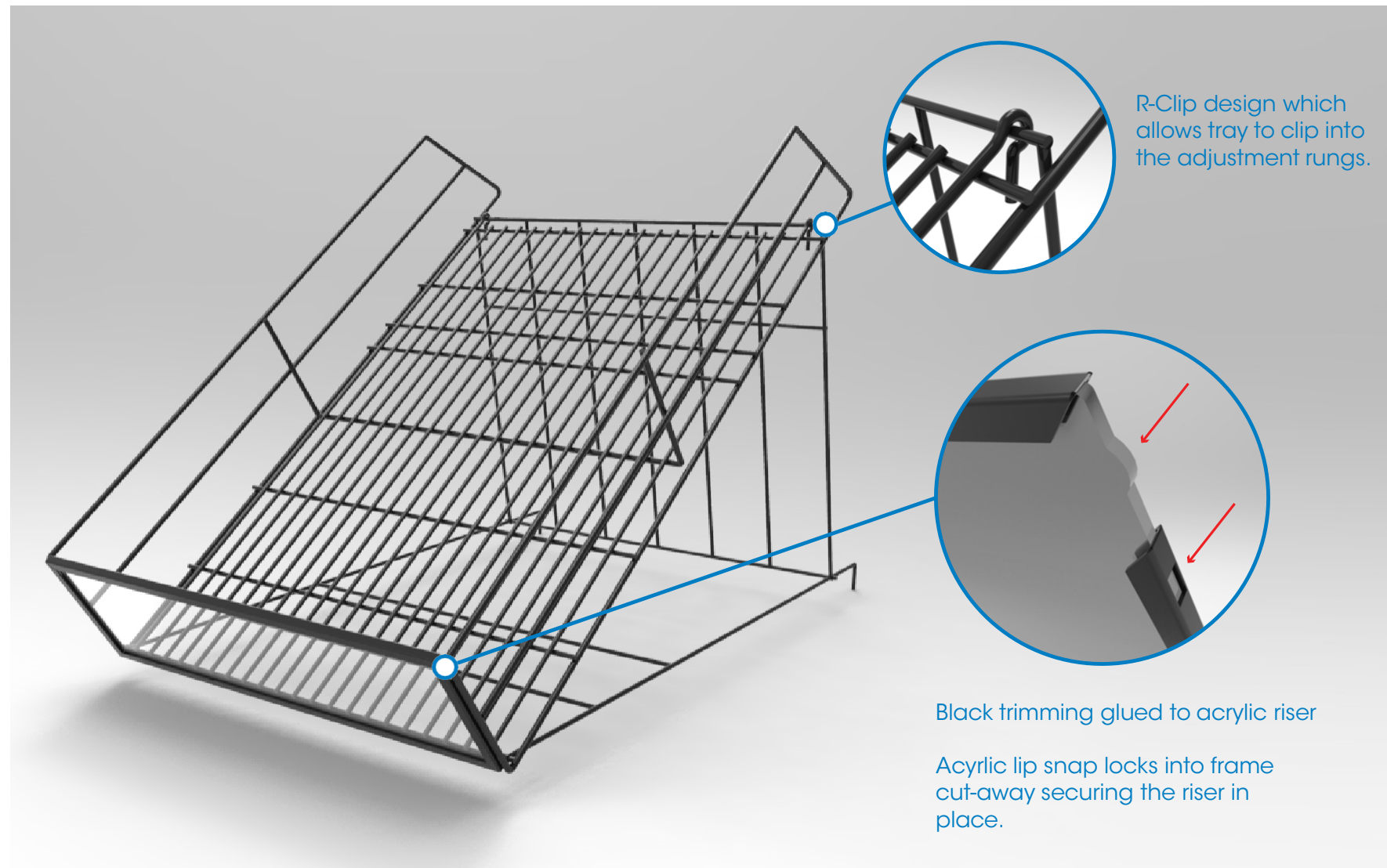



Box 1



Box 2





Included elements:

- Product Glorifiers
- Header Signage
- Data Strips
- Brochure Display Stands
- Visual Merchandising



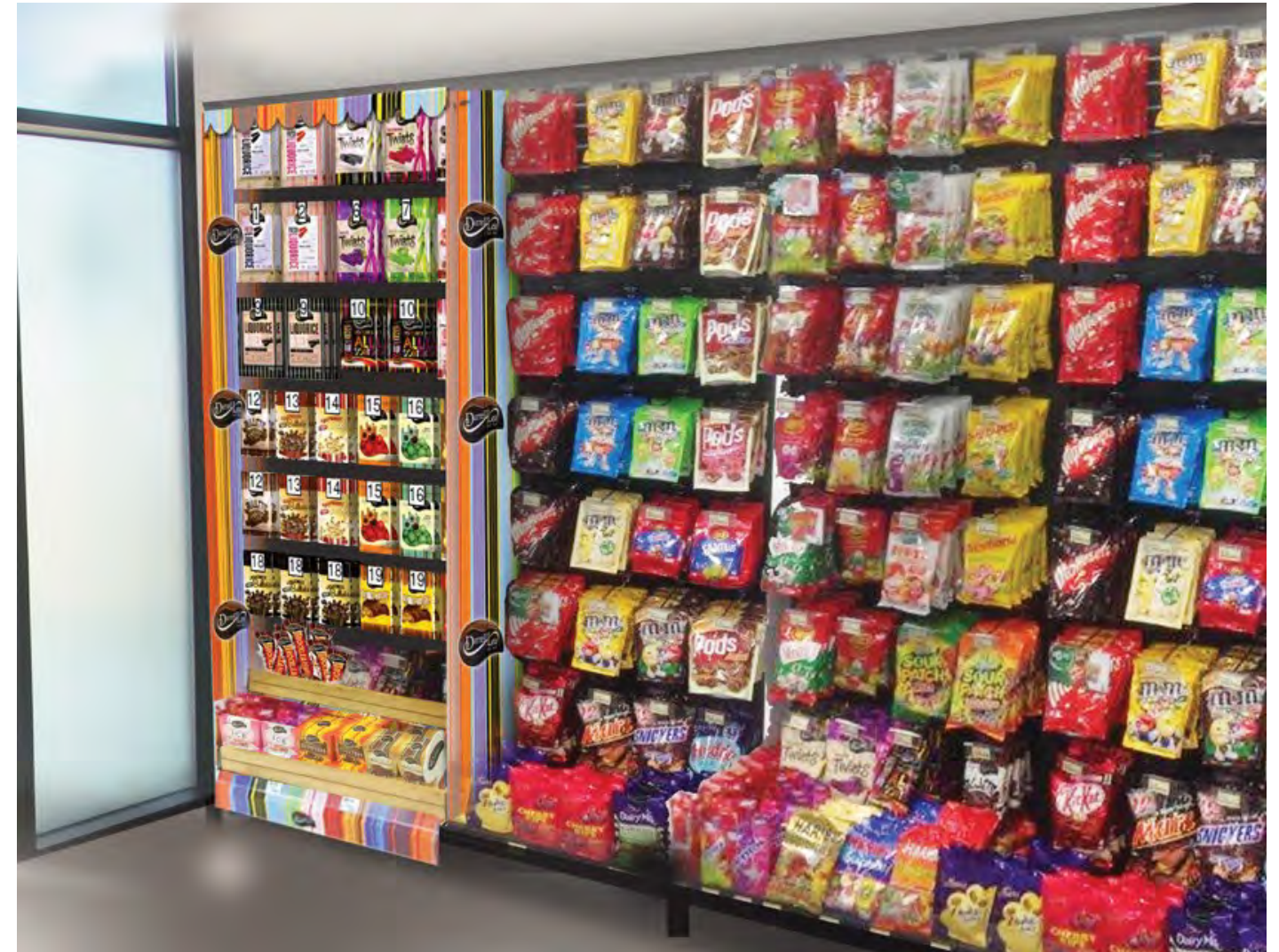



Lindt Pick & Mix - Toolless Construction

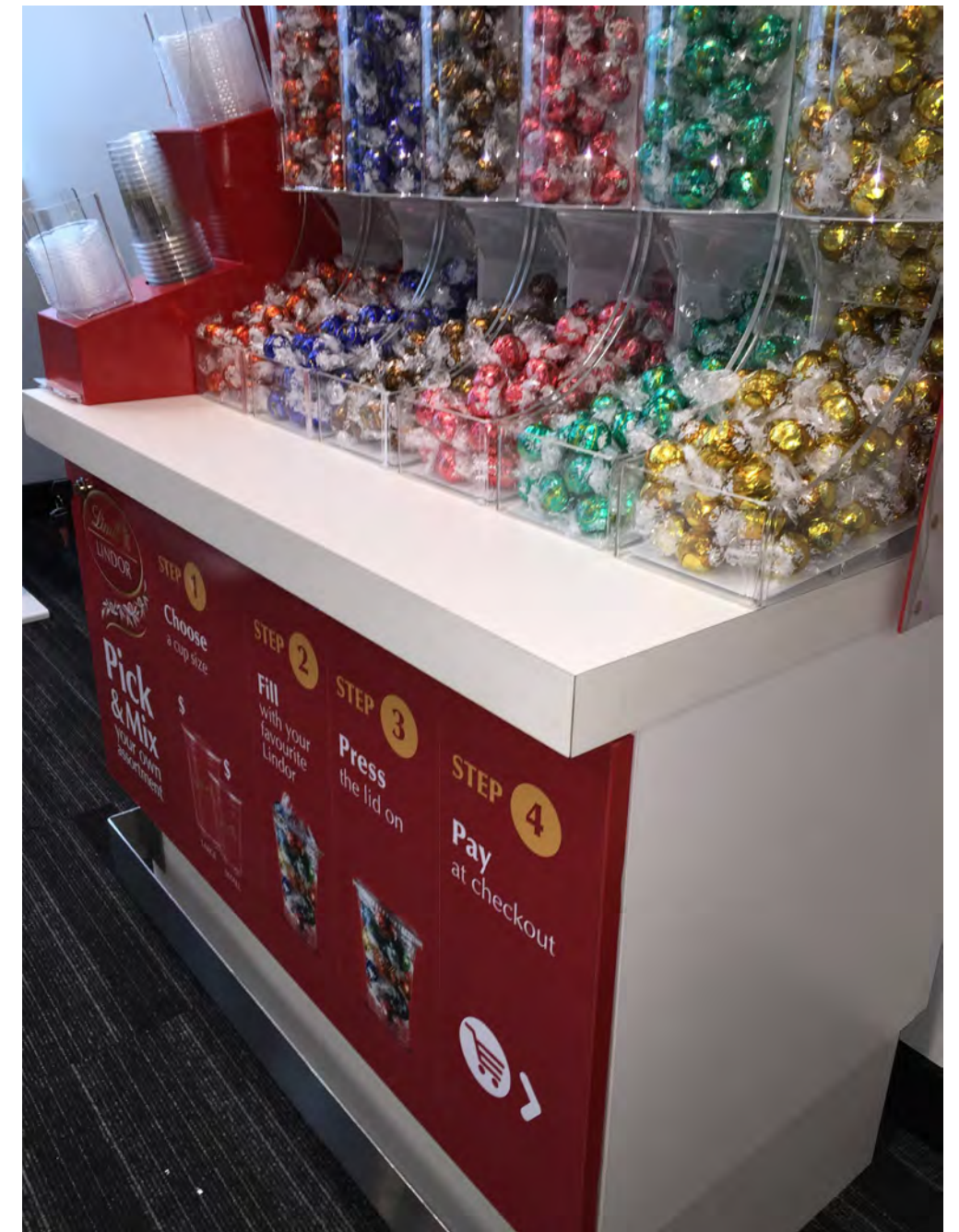
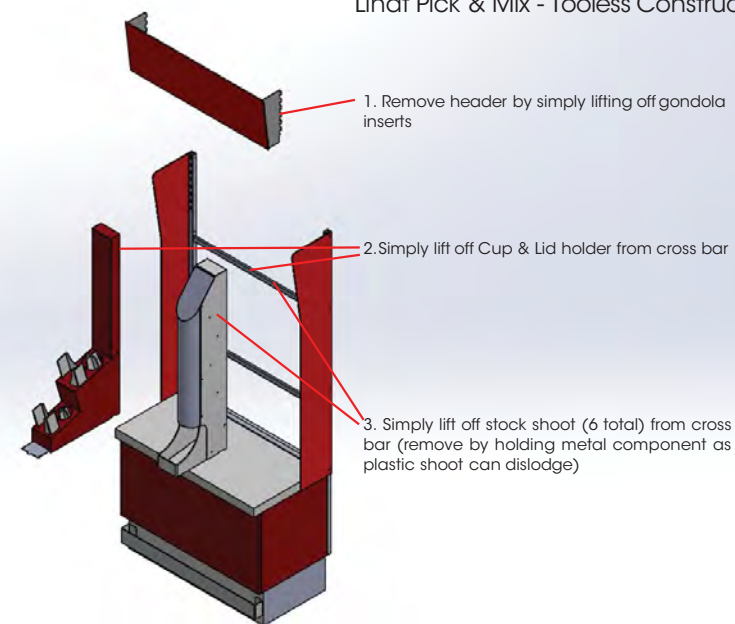



PROJECT: Hue Activation
And enhanced merchandising

MARKET: Consumer
Electronics and Hardware



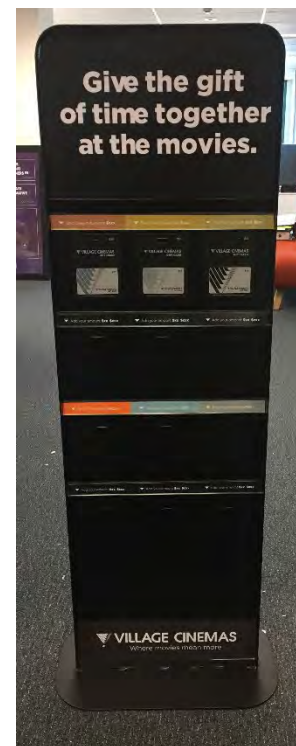
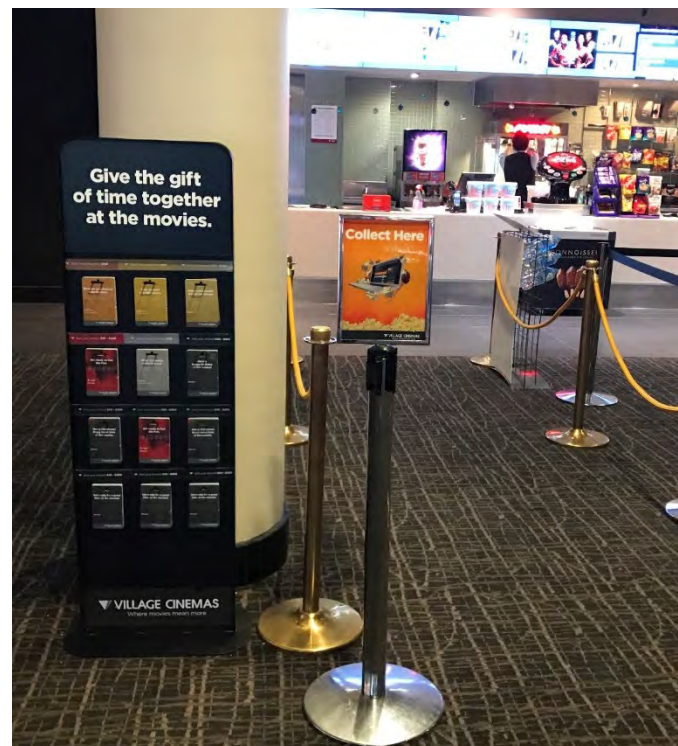
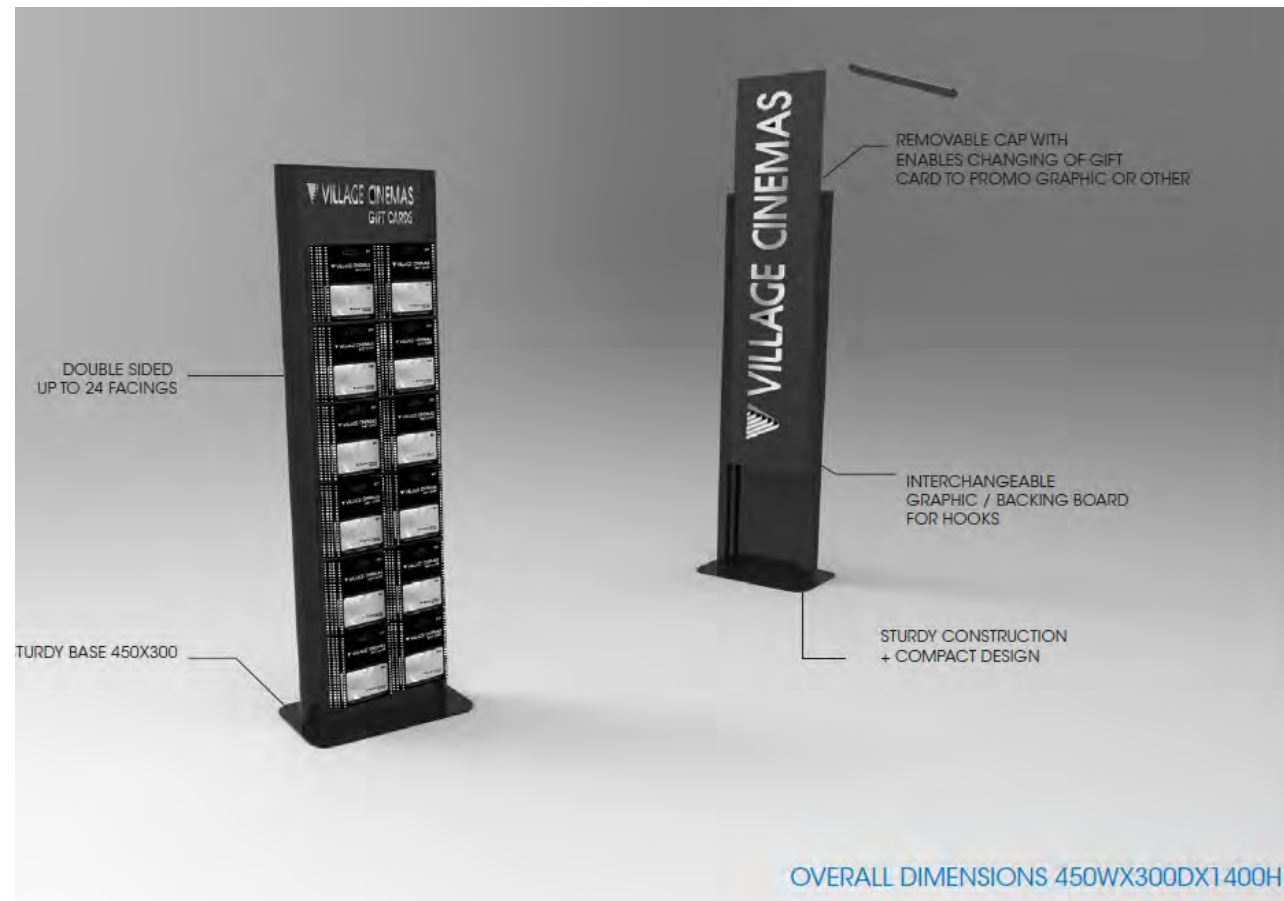

CONTACT US

General Enquiries: sales@sposgroup.com

SPOS Website



AUSTRALIA

SPOS Group
Level 2, 68-72 Waterloo Rd,
Macquaire Park, NSW 2113 Australia

Phone: +61 2 8667 4600

Mobile: 0478 351 407

NEW ZEALAND

Unit 1, 7 Henry Rose Place, Albany
Auckland 0632

Phone: +64 9 414 2210

Fax: +64 9 414 2219